

# H P P

High Pressure Processing Operation



I S O S T A T I C  
P R E S S

***Nano disperser***



02-05p Isostatic PRESS

06-09p Nano Disperser

10-21p HPP

23-24p Nano Disperser specification

25p Isostatic PRESS specification

26p HPP specification

※ 日新高温高压有限公司除了纳米分散机（微射流）意外，专门生产高温高压的相关设备登陆 [www.suflux.com](http://www.suflux.com) and [hpp.co.kr](http://hpp.co.kr) 可以了解更多的产品。

※ ILSHIN AUTOCLAVE is specialized in system with high pressure and high temperature and please visit web-page as "[www.suflux.com](http://www.suflux.com)", "[hpp.co.kr](http://hpp.co.kr)" for more information.



# 02-05p Isostatic PRESS

ISOSTATIC  
P R E S S  
Wet-bag system

web site : [www.suflux.com](http://www.suflux.com)

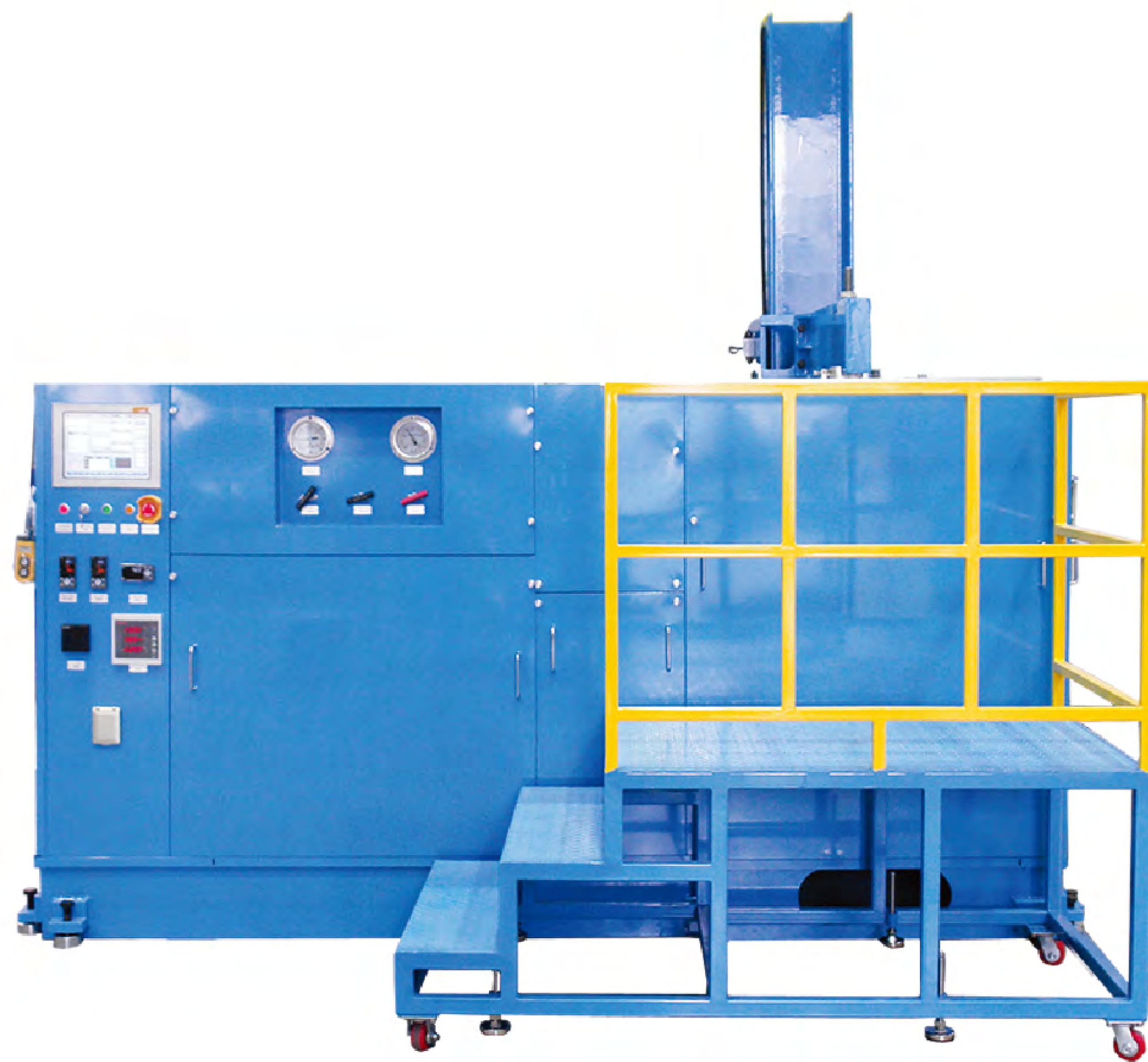



# I S O S T A T I C P R E S S

## Isostatic Press 等静压机

The Isostatic Press is the product using a fluid that exert equal pressure in all directions. The equal force could be exert in all direction by pressure from a inner fluid. It is used be isostatic pressing and laminatin in material processing. Adn it is also used to sterilize in food processing.

等静压机是使用流体在各个方向施加相同压力的产品。等力可以通过内部流体的压力在所有方向上施加压力。用于材料加工中的等静压和层压。也用于食品加工的灭菌。

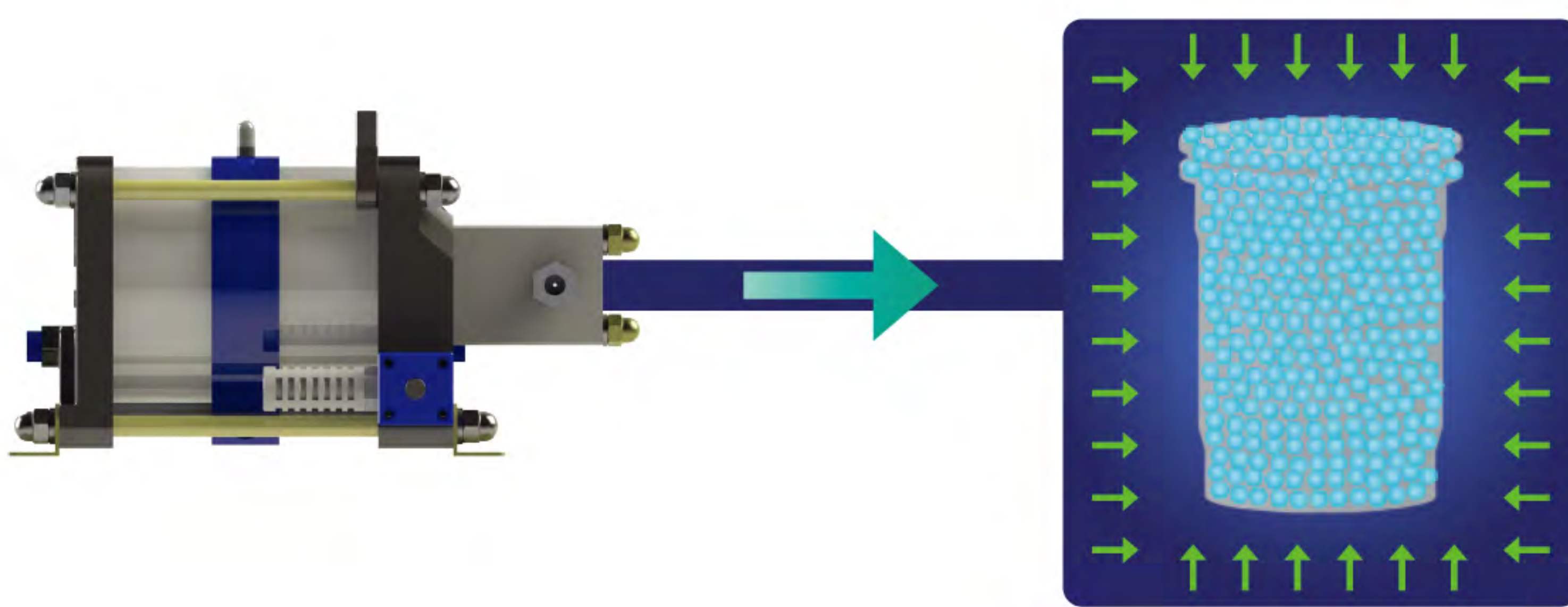

## Feature 特点

### Customized order 定制订单

- 1 To reflect customer's various opinions  
反映客户的各种意见
- 2 To add options of fuction  
可以添加功能的选项
- 3 To minimize processing/  
Maximalize efficiency  
最小化处理/效率最大化

### Technology 技术力

- 1 To Possess high pressure certification  
such as ASME and SEL  
拥有高压认证 如ASME和SEL
- 2 To Possess high pressure Wire  
Wounding technology  
拥有高压技术
- 3 Rich experience about  
high pressure system  
丰富的经验 高压系统

### Competitiveness 竞争力

- 1 A competitive price  
(Self-manufacturing spare part to system)  
有竞争力的价格(自制零件到系统)
- 2 Rapid response  
快速反应
- 3 Construction product designing system  
驱逐设备制造体系

### Convenient 方便性

- 1 for using  
驱逐使用者方便性的设计
- 2 for program designing  
方便的系统设计
- 3 for maintaining  
方便的维护

### CIP (Cold Isostatic Press)

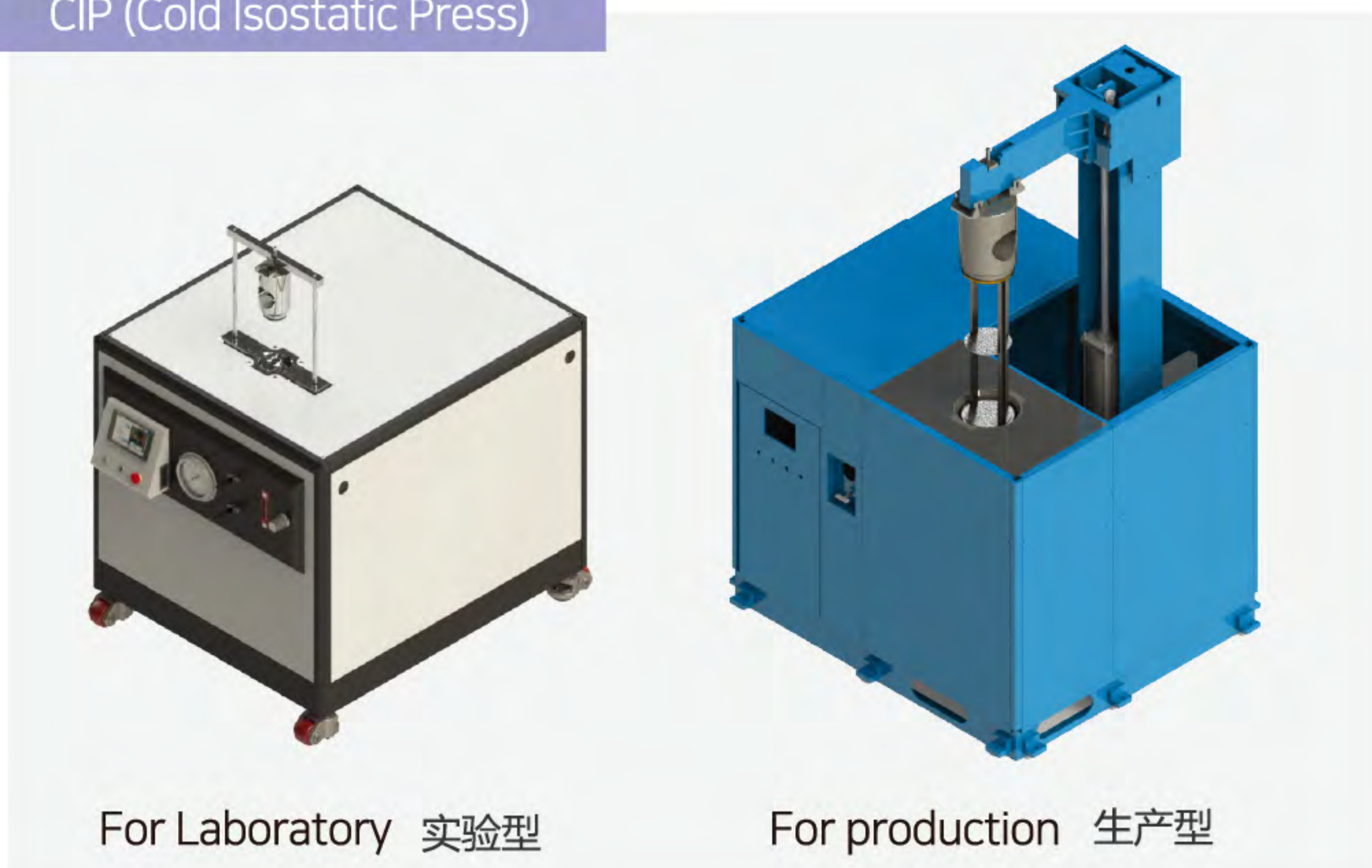

For Laboratory 实验型

For production 生产型

### WIP (Warm Isostatic Press)



For Laboratory 实验型

For production 生产型



# WIP (Warm Isostatic Press)

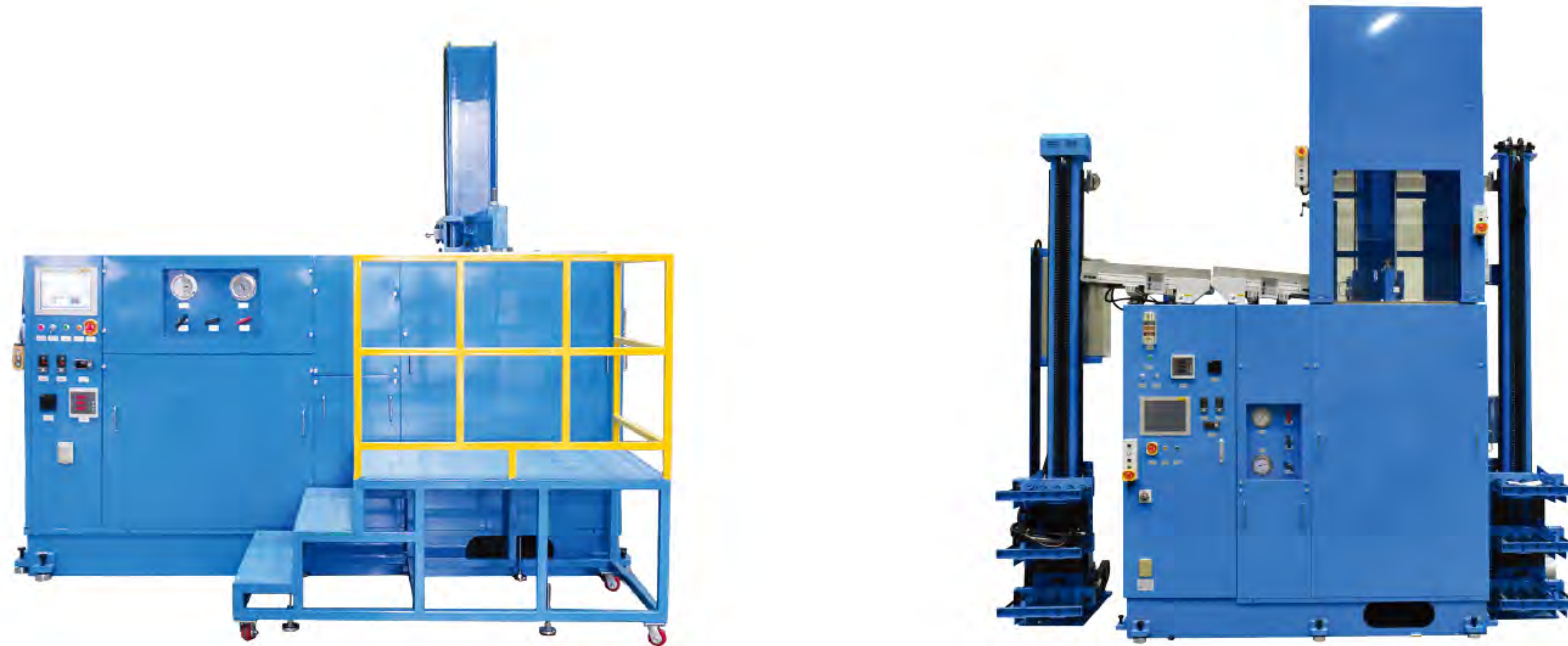

**sflux**® a leader in custom-engineered high-pressure solutions, develops its Warm Isostatic Press Production Unit(WIP), a press with a high-pressure vessel and pressurized fluid heating to 85°C

Designed for high productivity and low maintenance, **sflux**'s Warm Isostatic Presses(WIP) are ideal for all applications requiring moderate temperature during the application of pressure and can be customized to suit application-specific needs.

**sflux**'s Warm Isostatic Presses(WIP) are capable of operating at pressures up to 2,000bar, with control of pressurization and decompression. This results in products of uniform density; reducing internal stresses, cracks, strains and laminations in the parts being processed.

作为定制设计的高压解决方案的领导者, **sflux** 开发了其等温压生产设备(WIP), 一台带有高压容器和加压流体加热到85°C。专为高生产率和低维护而设计, **sflux** 的热静压机(WIP)适用于所有需要中等温度的应用在施加压力期间的温度, 并且可以被定制以适应应用特定的需要。

**sflux** 的温均衡压力机(WIP) 能够在高达2,000bar的压力下运行, 同时控制加压和减压。这导致密度均匀的产品; 减少被加工部件的内部应力, 裂纹, 应变和叠片。

## The Areas of Application (应用领域)

Laminating hybrid chips, MLCCs, Ferrites, Multi-layer PZTs, LTCC, Electronic filters ceramics, Metals, Composites, Plastics, Carbon.  
(层压混合芯片, MLCC, 铁氧体, 多层PZT, LTCC, 电子滤波器陶瓷, 金属, 复合材料, 塑料, 碳。)

## Lamination Process (层压工艺)

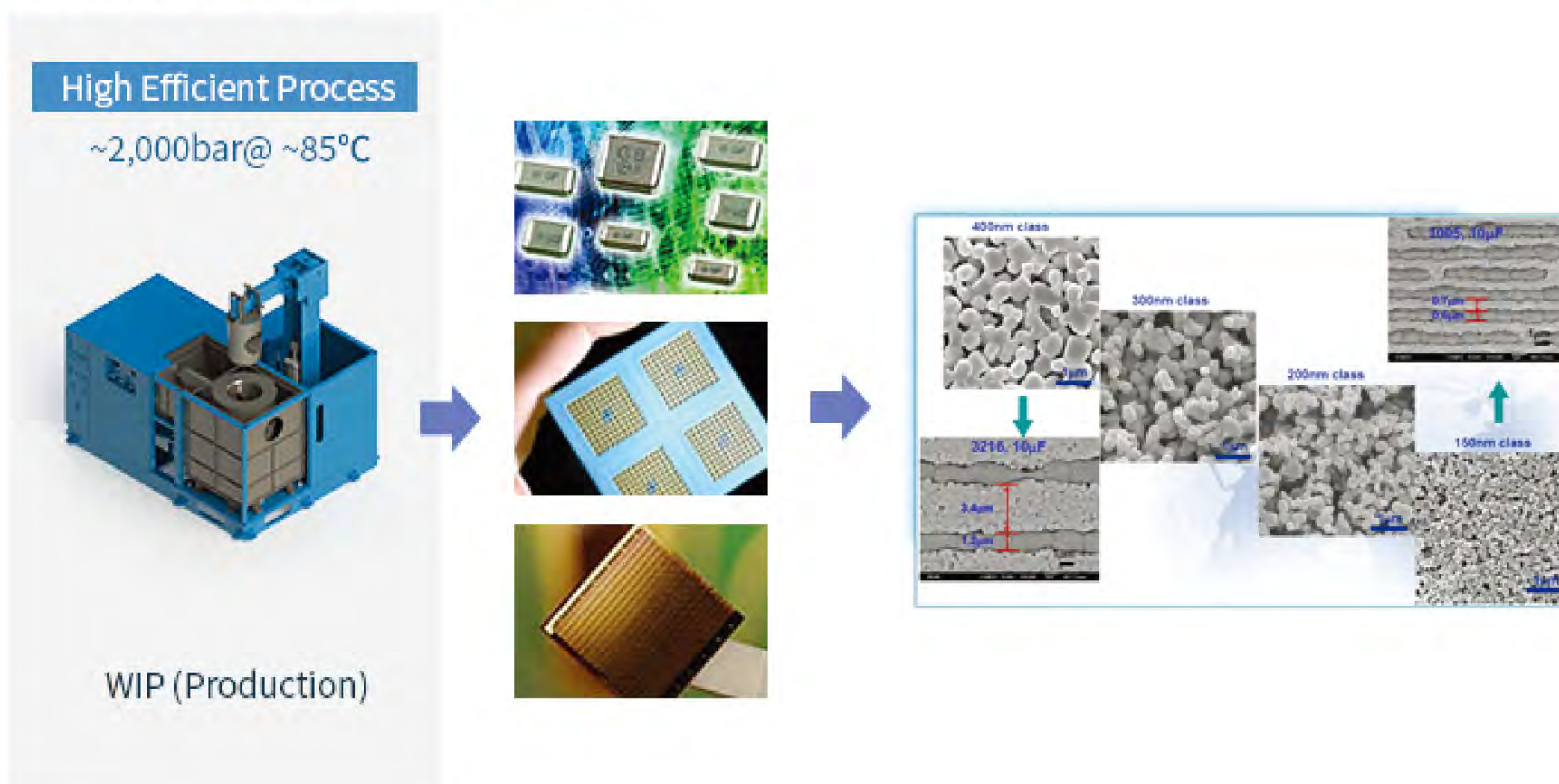



# MLCC

MLCC(Multi-layer ceramic capacitors) consists of a number of individual capacitors stacked together in parallel and contacted via the terminal surfaces. MLCC's are the most produced and used capacitors in electronic equipment as mobile and PC, Appliances, Automotive, Military&Defence, Aerospace, etc...

MLCC(多层陶瓷电容器)由多个独立的电容器并联在一起组成通过端子表面接触。MLCC是电子设备中生产和使用最多的中空聚手机和个人电脑, 家电, 汽车, 军事和国防, 航空航天等。

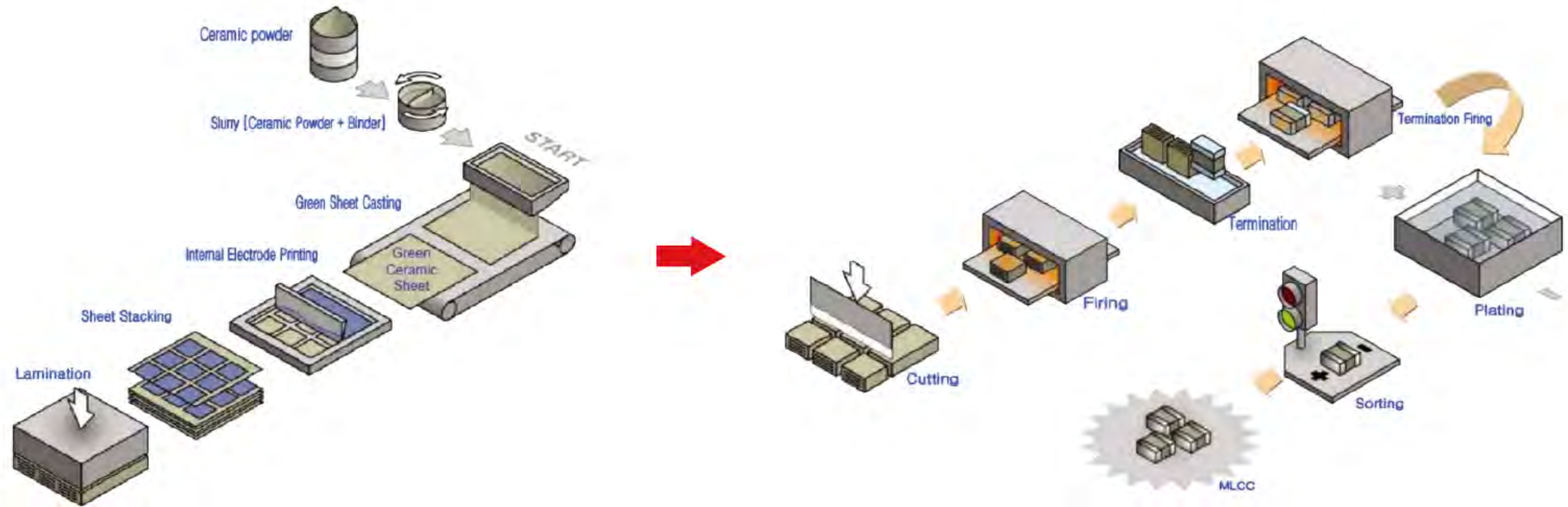
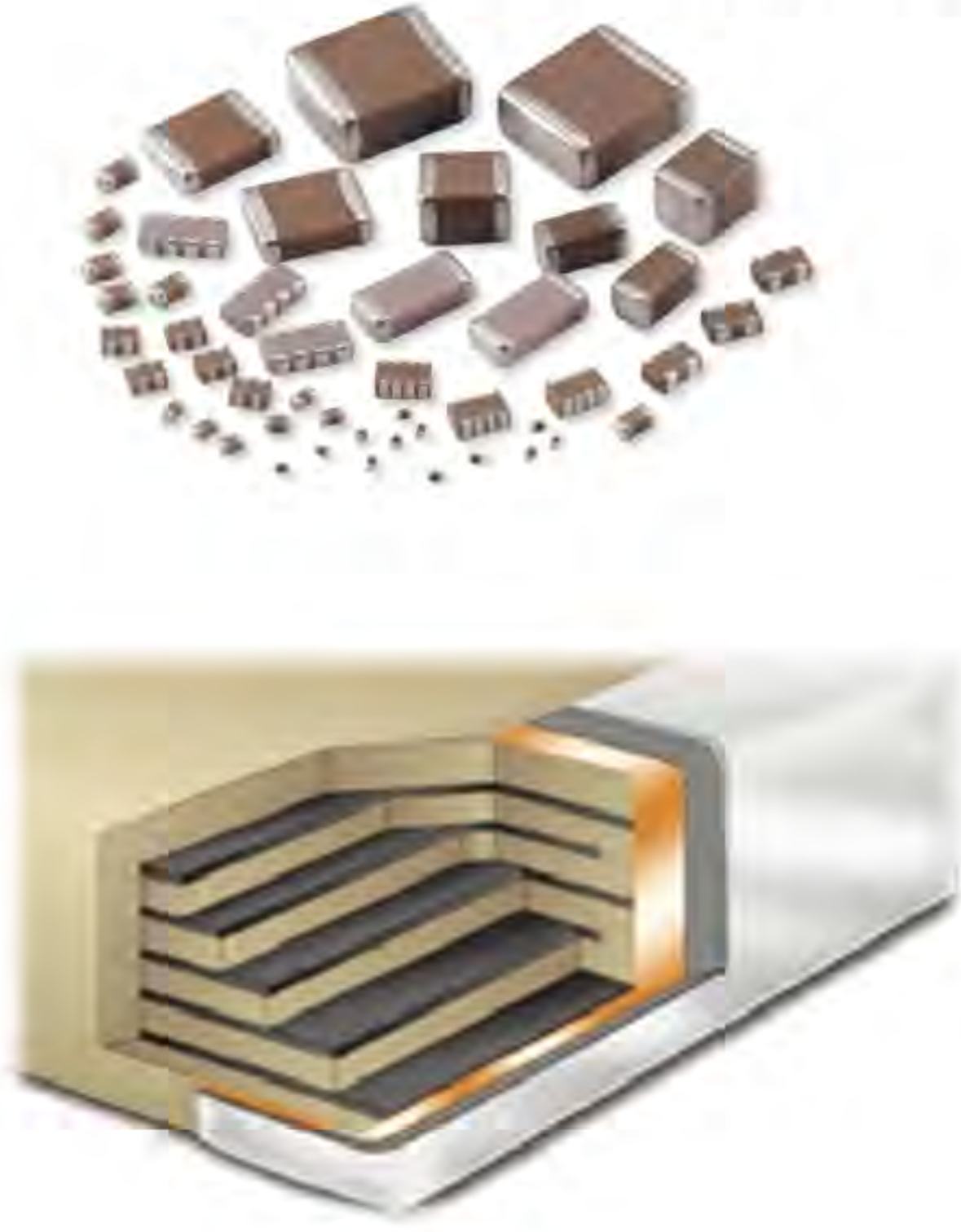

## Feature Details 功能详情

**suflux's** Warm Isostatic Presses(WIP) are available in a variety of sizes from pilot to large production units, and feature top closure and load handling systems designed to meet the customer's production requirements. The Warm Isostatic Presses(WIP) are equipped with safety and alarm devices, adjustable pressure set-points, dwell time and fluid drain settings.

**suflux** 的冷等静压机 (WIP) 有各种尺寸可供选择试点大生产单位, 并具有顶部封闭和负载处理系统设计来满足客户的生产要求。热等静压机(WIP)是配有安全和报警装置, 可调压力设定点, 停留时间, 和流体排放设置。

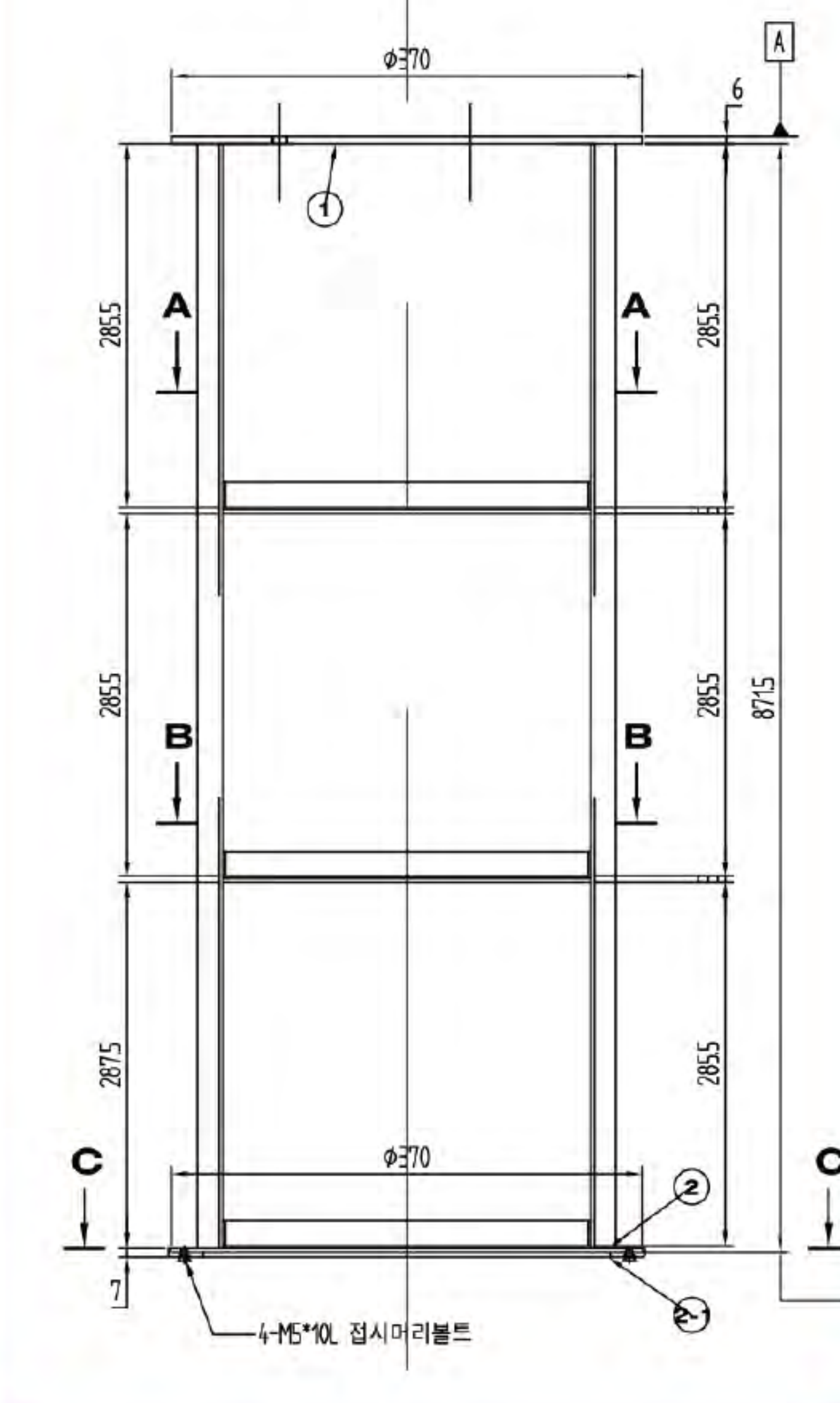
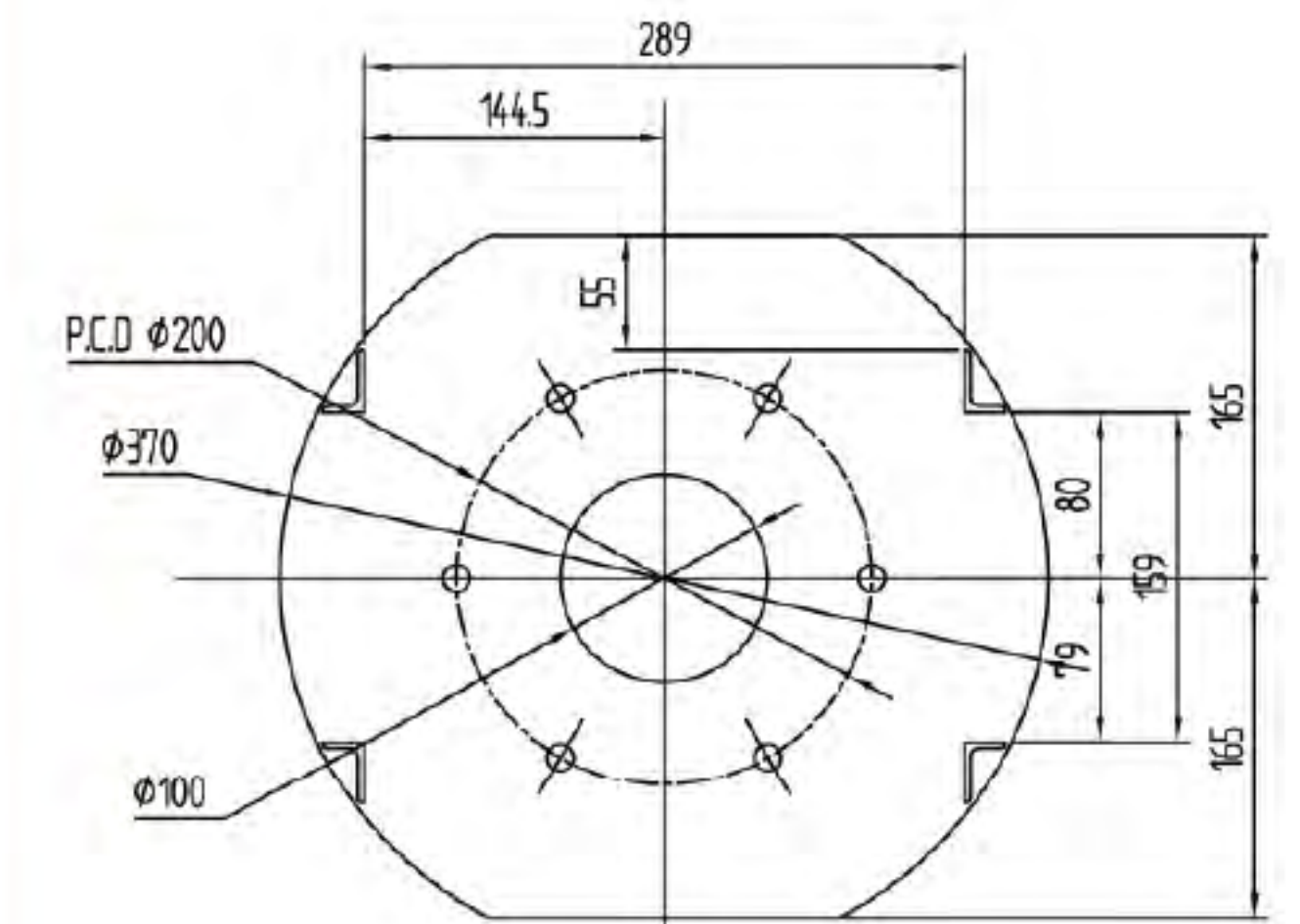
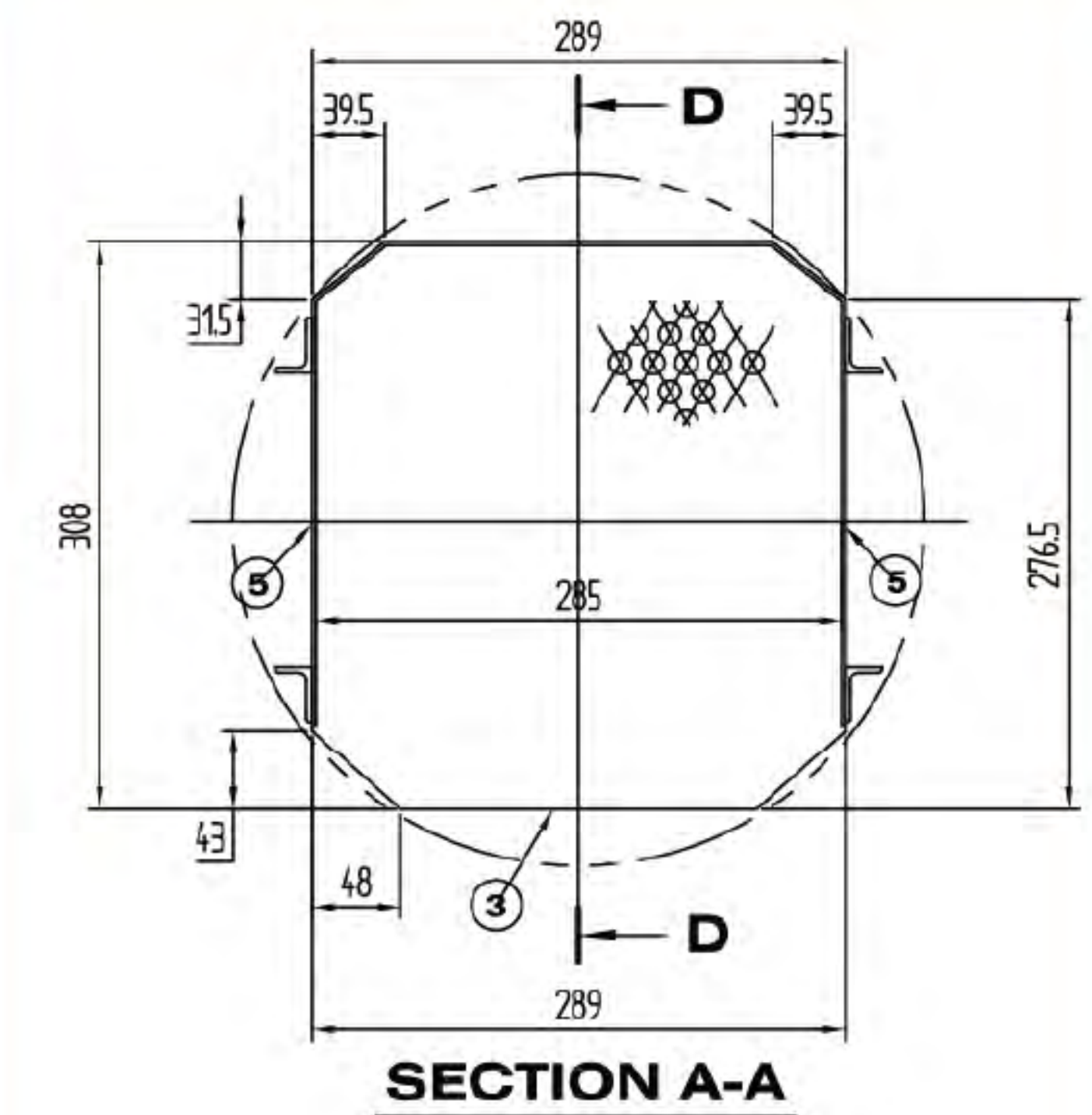
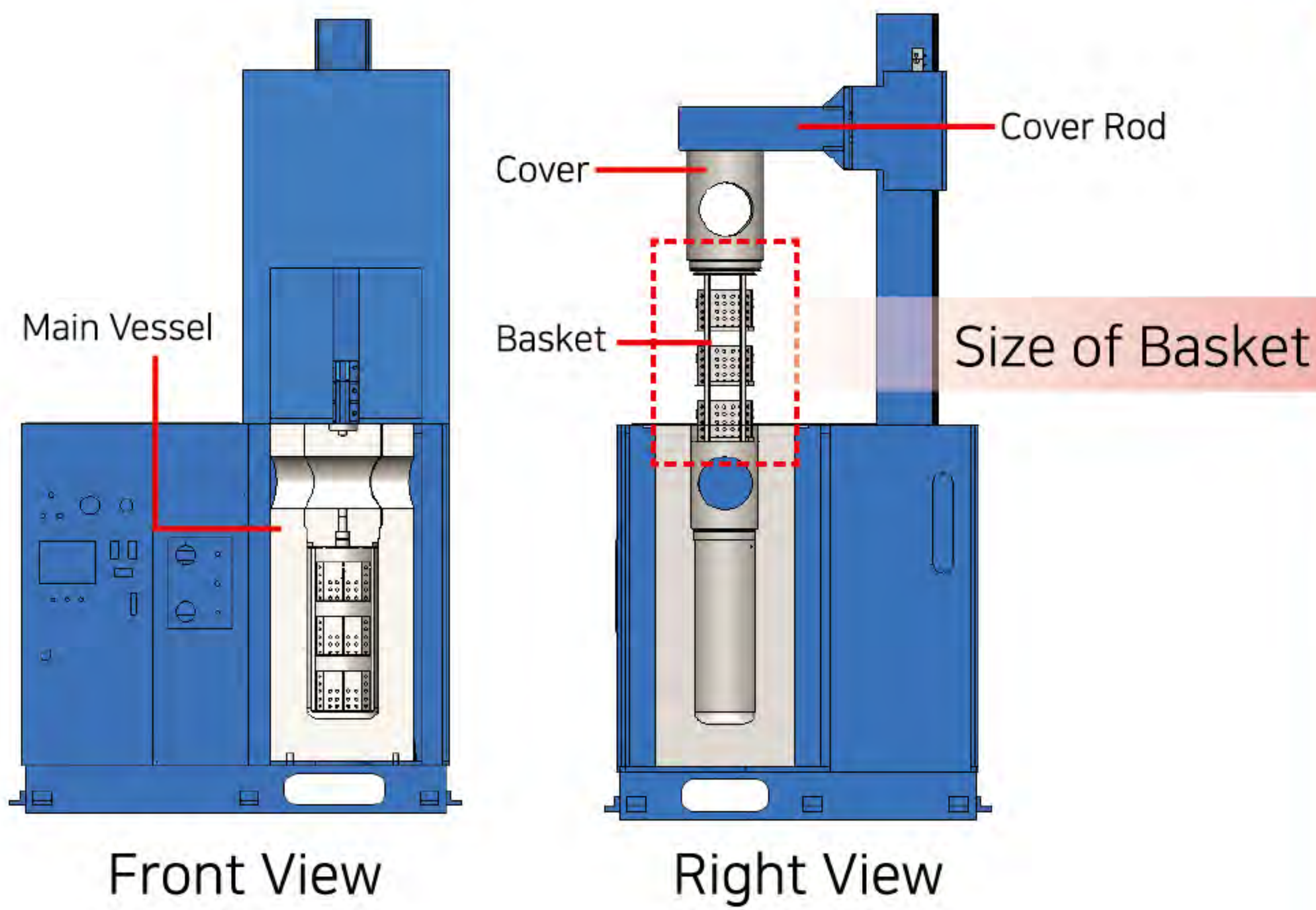

## Closing type



C-clamp Type

Closing type : C-clamp

- 1 Pressure: Under 1,000bar
- 2 Temperature : Ordinary temperature to 80 degrees
- 3 Capacity : Customized
- 4 Air Driven Liquid Pump/Hydraulic Pump
- 5 O-ring/U-packing/Energizer seal
- 6 CIP/WIP



Pin Closing Type

Closing type : Combination Pin and Cover

- 1 Pressure: Up to 4,000bar & Customized
- 2 Temperature : Ordinary temperature to 120 degrees
- 3 Capacity : Up to 100L & Customized
- 4 Air Driven Liquid Pump/Hydraulic Pump
- 5 O-ring/U-packing
- 6 CIP/WIP/FIP for laboratory

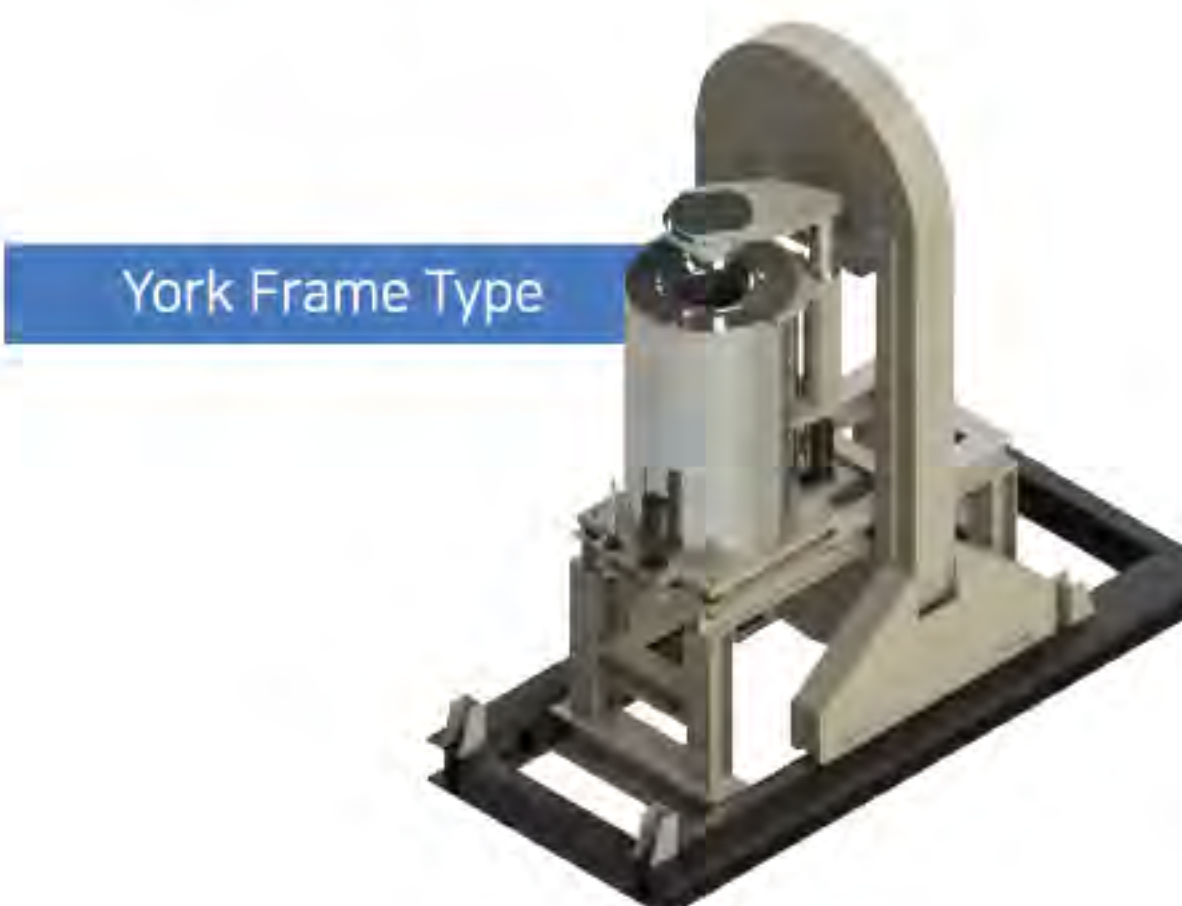
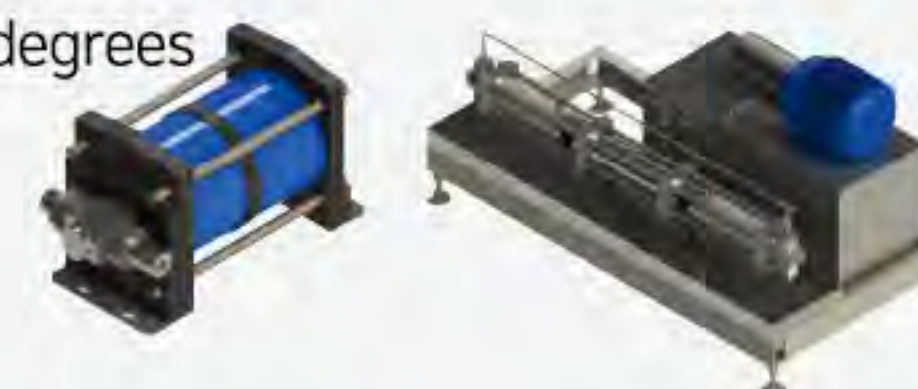

York Frame Type

Closing type : Combination York Frame and vessel part

- 1 Pressure: Up to 6,000bar
- 2 Temperature : Ordinary temperature
- 3 Capacity : Up to 200L & Customized
- 4 Hydraulic Pump
- 5 O-ring/U-packing/Energizer seal
- 6 CIP/FIP(Wire winding)





06-09p

Nano Disperser

**Nano Disperser**

web site : [www.suflux.com](http://www.suflux.com)





# High Pressure Homogenizer System

## High pressure homogenizer system

With different operation method unlike conventional disperse, crushers or emulsion equipments, it can produce micro particle with  $0.01\mu\text{m}$  size. No intrinsic physical property change because of constant pressure and instant treatment method for production process (Uniform particle distribution, complete homogeneous, productivity improvement). It provides improved treatment speed because of continuous input of materials for production.

It's distinguishable performance and durability due to self developed diamond micro orifice module. Easy flux control and cleaning of liquid contact section when replacement of materials. Easy operation for repetition test and pressure readjustment. Easy to scale up and down of flux to have continuous process stabilization.

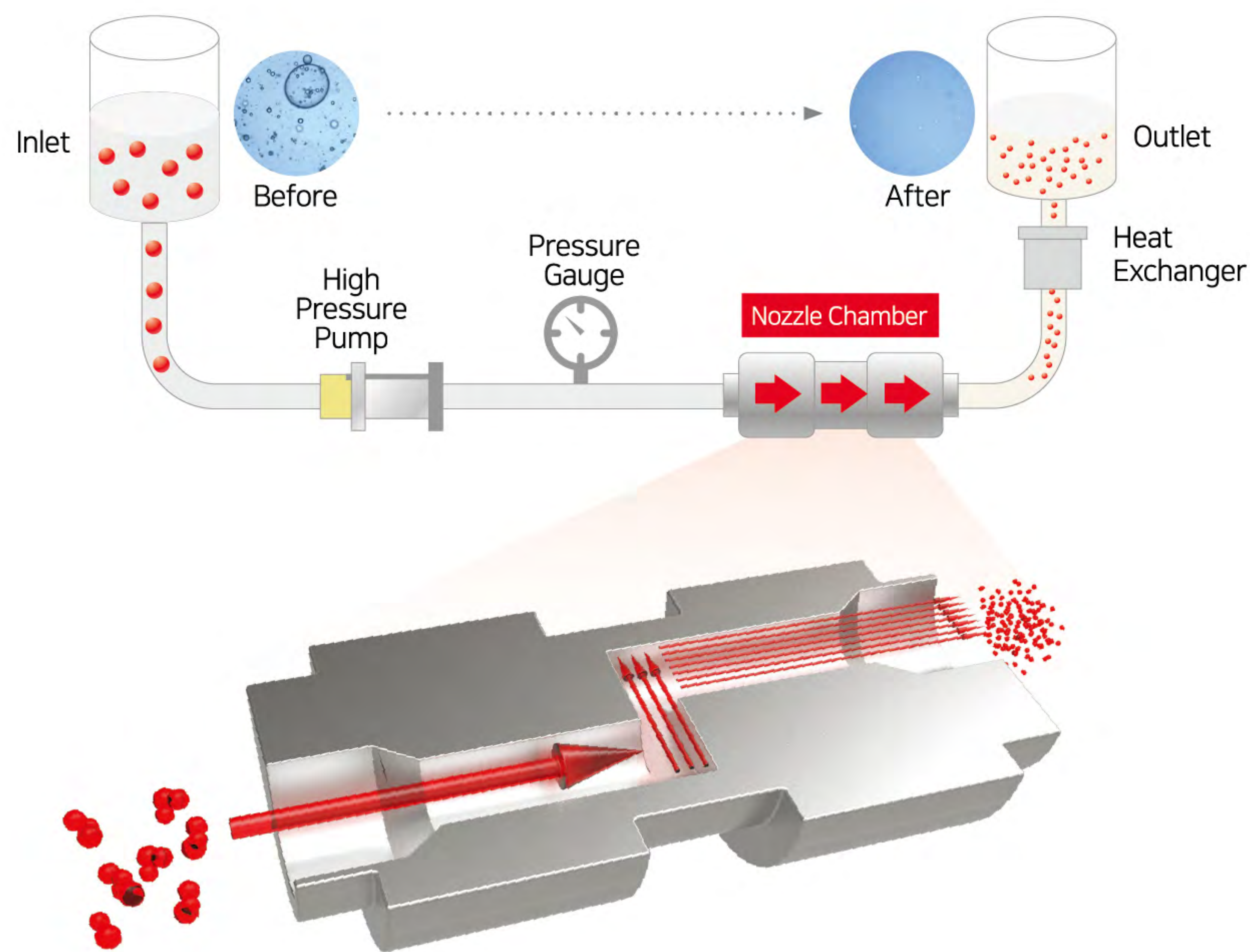

### IMPACT

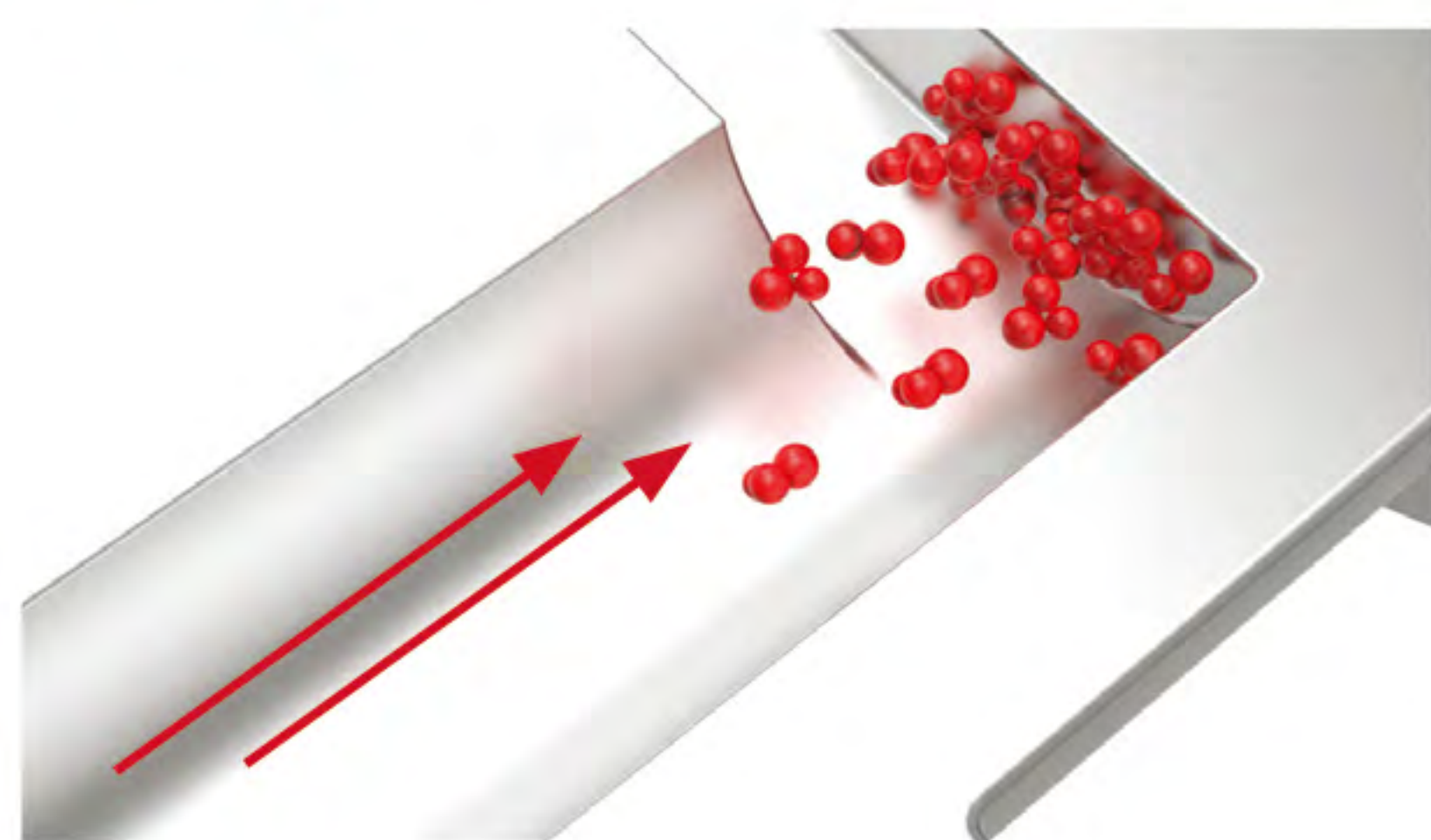

Surface tension, internal friction force in the orifice and shear force in the fluid by viscosity occurs.

### SHEAR FORCE

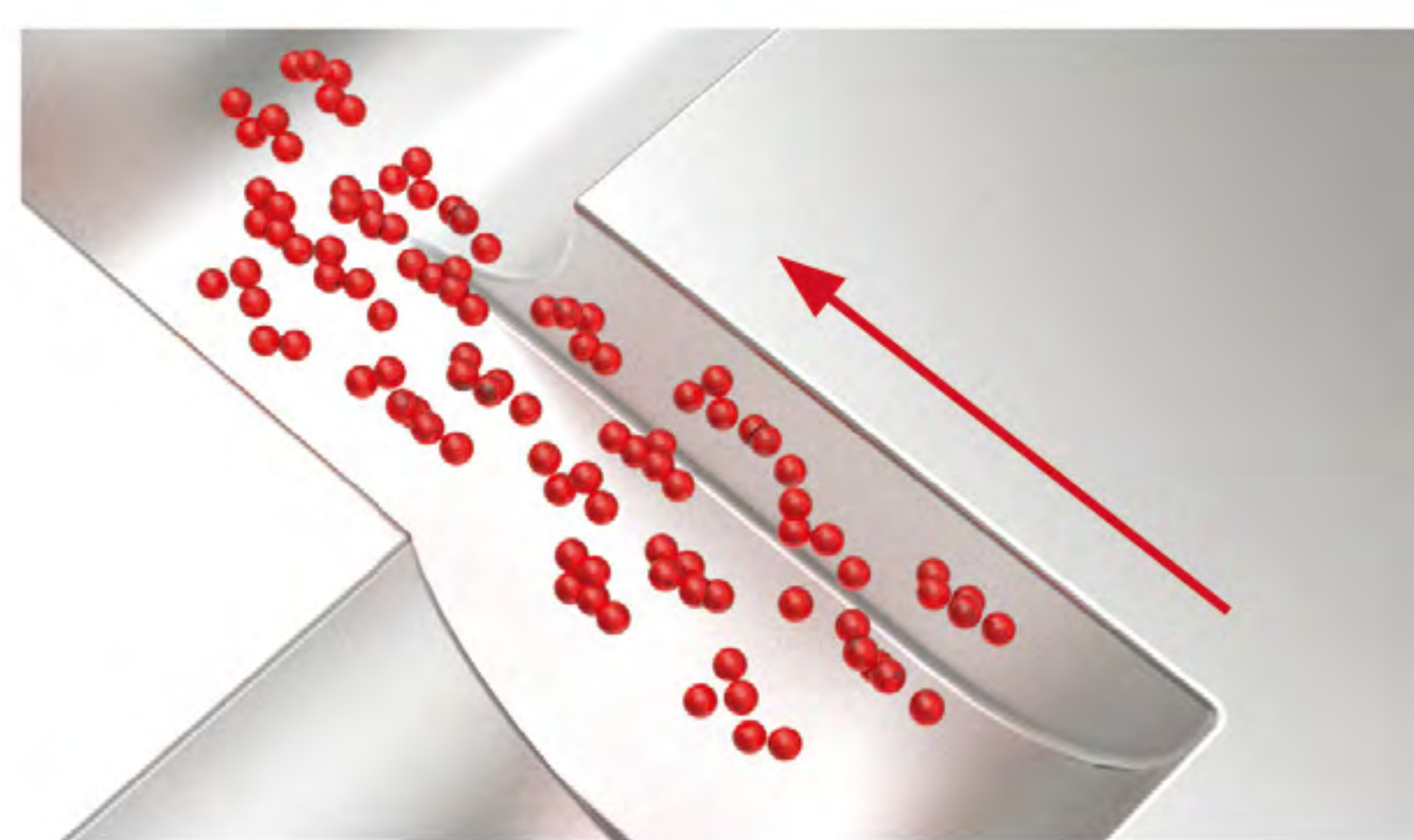

When the cavitation bubbles collapse, they force liquid energy to very small volumes, thereby impact between fluid particles occurs.

### CAVITATION

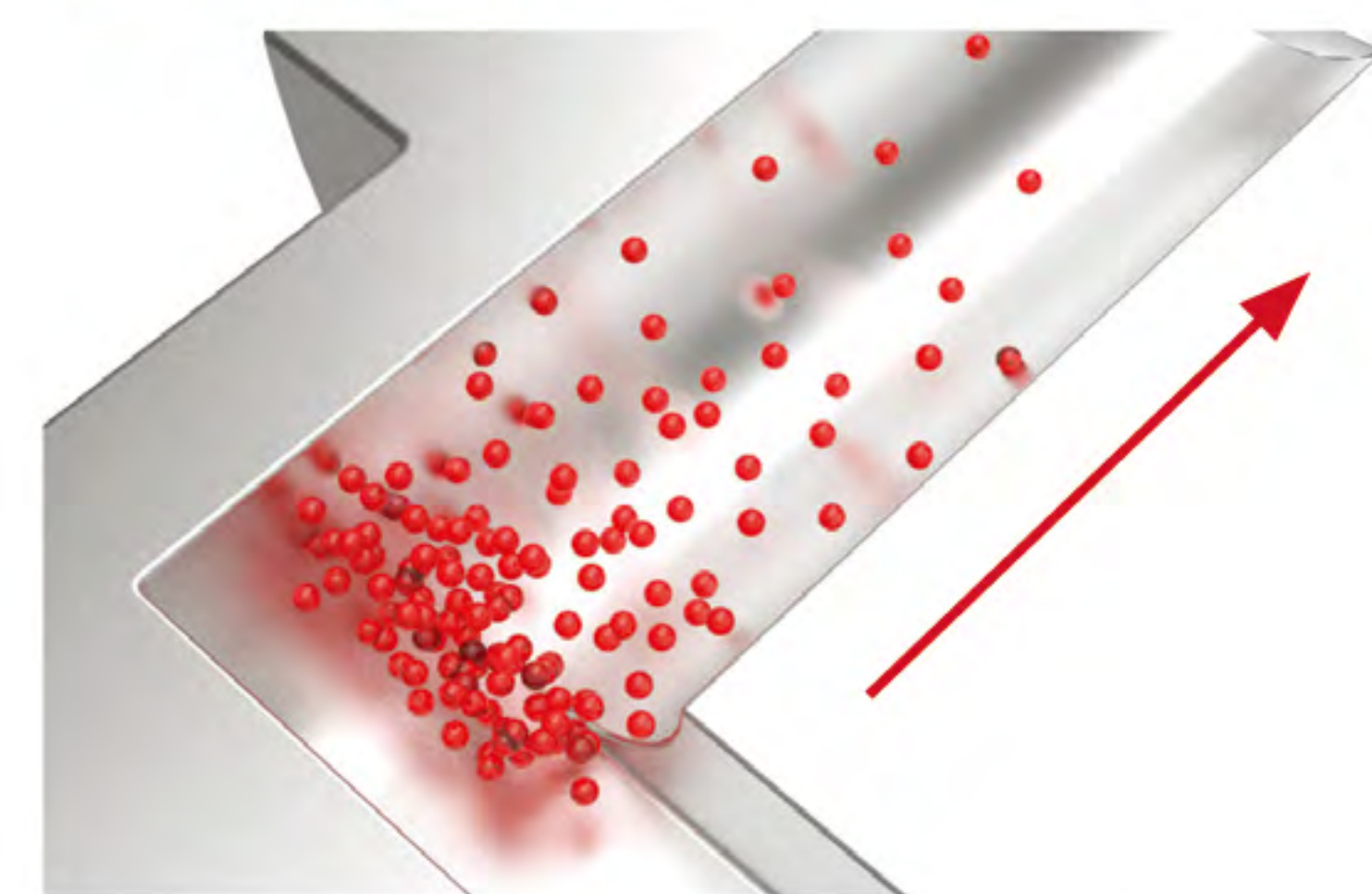

The cavitations means the behavior of voids or bubbles in a liquid. If energy is increased, then cohesive power between molecules and a void or bubble in a liquid rapidly collapses, producing a shock wave.

### IMPACT

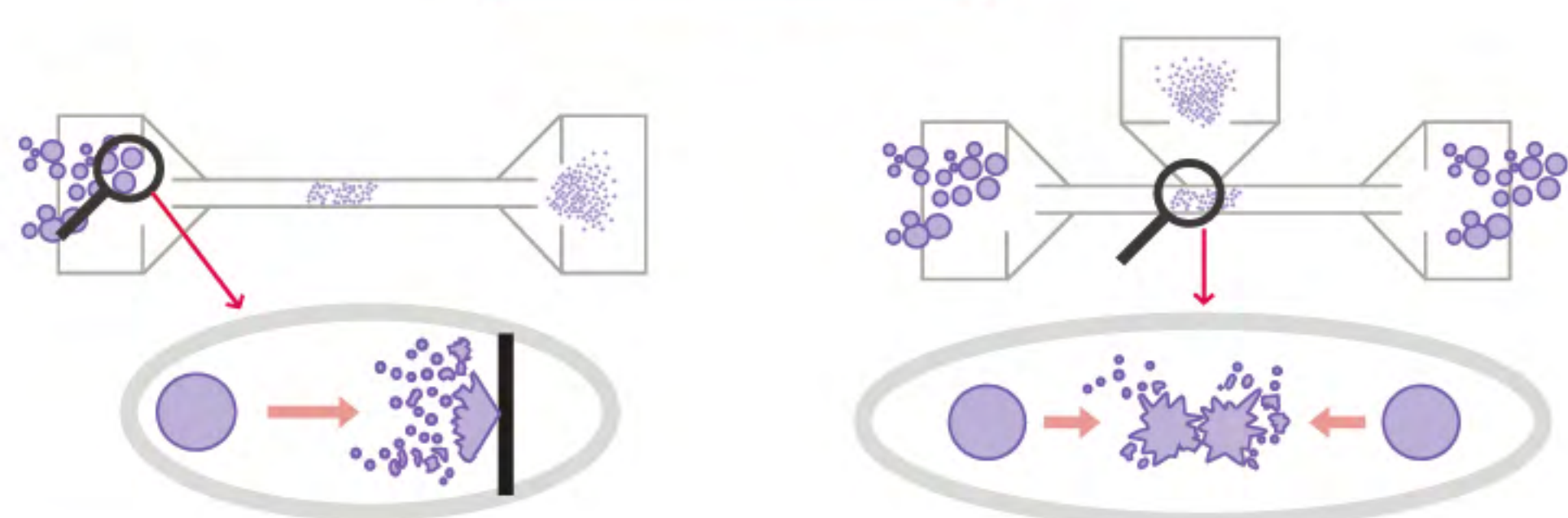

### SHEAR FORCE

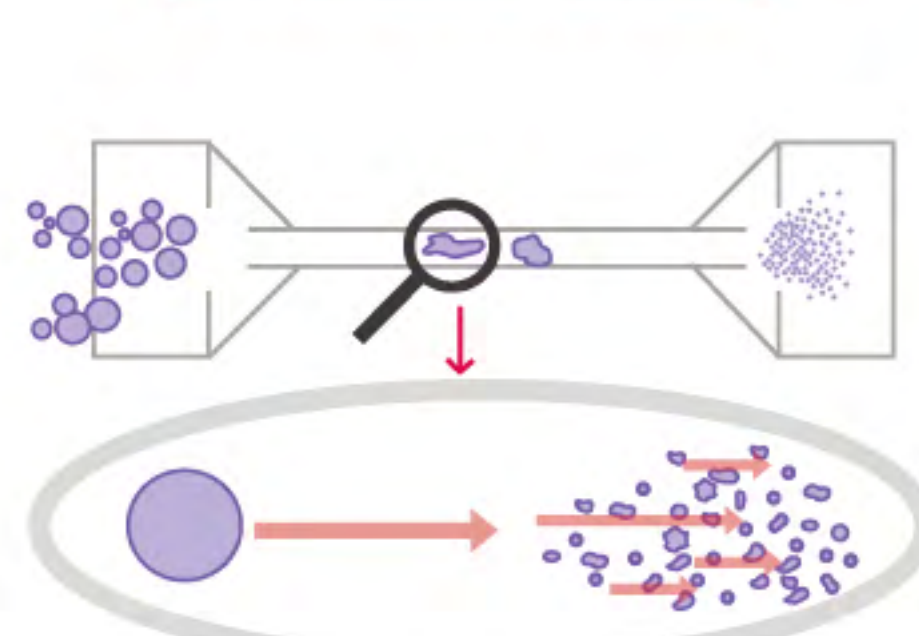

### CAVITATION

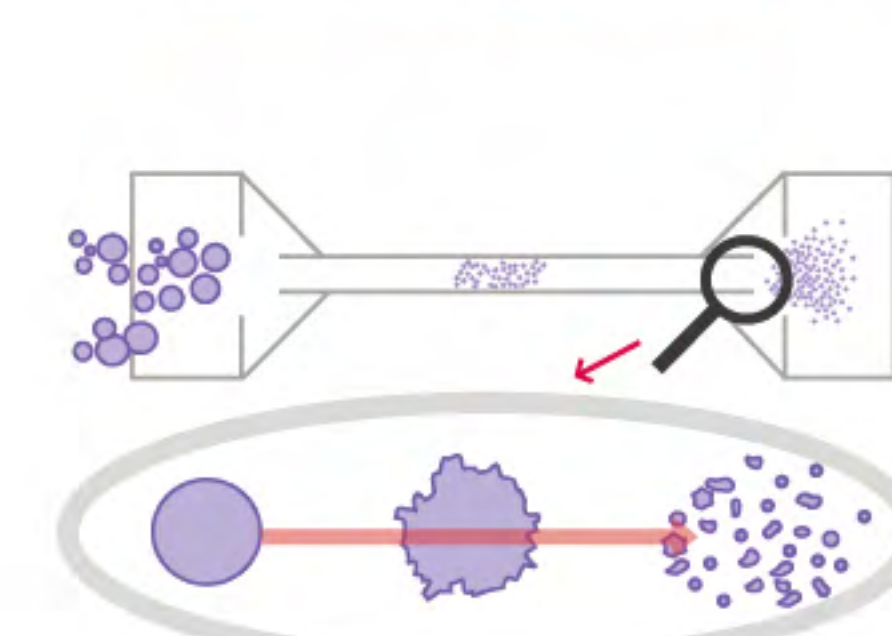



# 纳米均质分散机 (微射流) 系统

## 纳米均质分散机 (微射流) 系统

高压流体在加压状态下通过细孔模块时压力急剧下降而形成超声波流速。此时的流体内会发生粒子冲击, 空化和湍流, 剪切, 应力作用下流体细胞的破坏, 雾化, 乳化, 分散, 脂质体等现象, 使用现有的智能搅拌机, 超声波, 球磨机等, 相对于其它技术具有更高效率的电子材料, 生物工程, 制药, 食品, 纤维, 涂料, 化妆品等产业, 以至适用于广泛的领域。

Nano-Dispenser过程是增加器发动而引发的高压流体在分散单元的狭小缝隙间快速通过。此时流体内压力的急剧下降而形成的超声速流速, 流体内的粒子碰撞, 空化及湍流, 剪切力作用于劈开纳米大小的细微分子使流体的成分以完全的均质的状态存在。

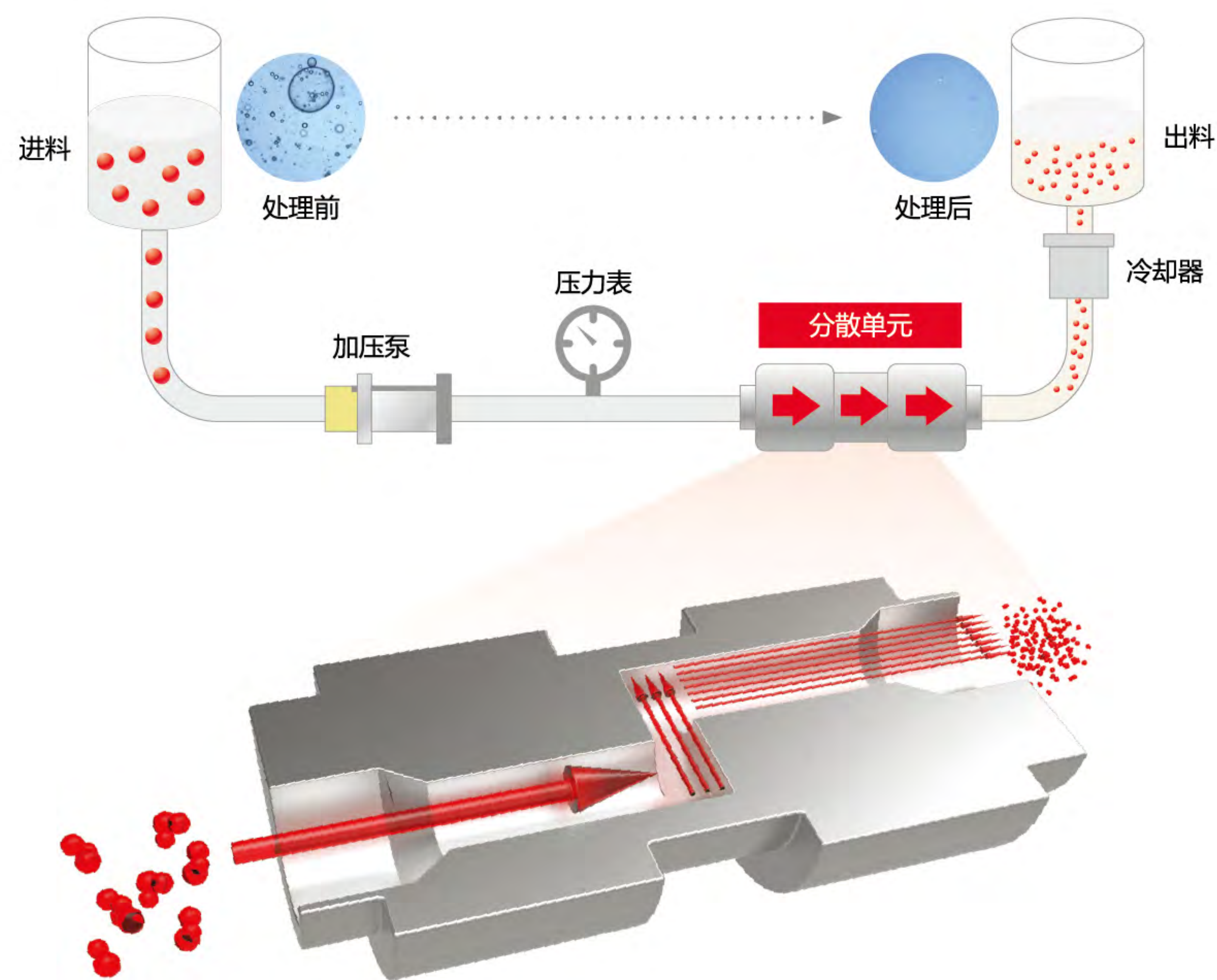

### 撞击

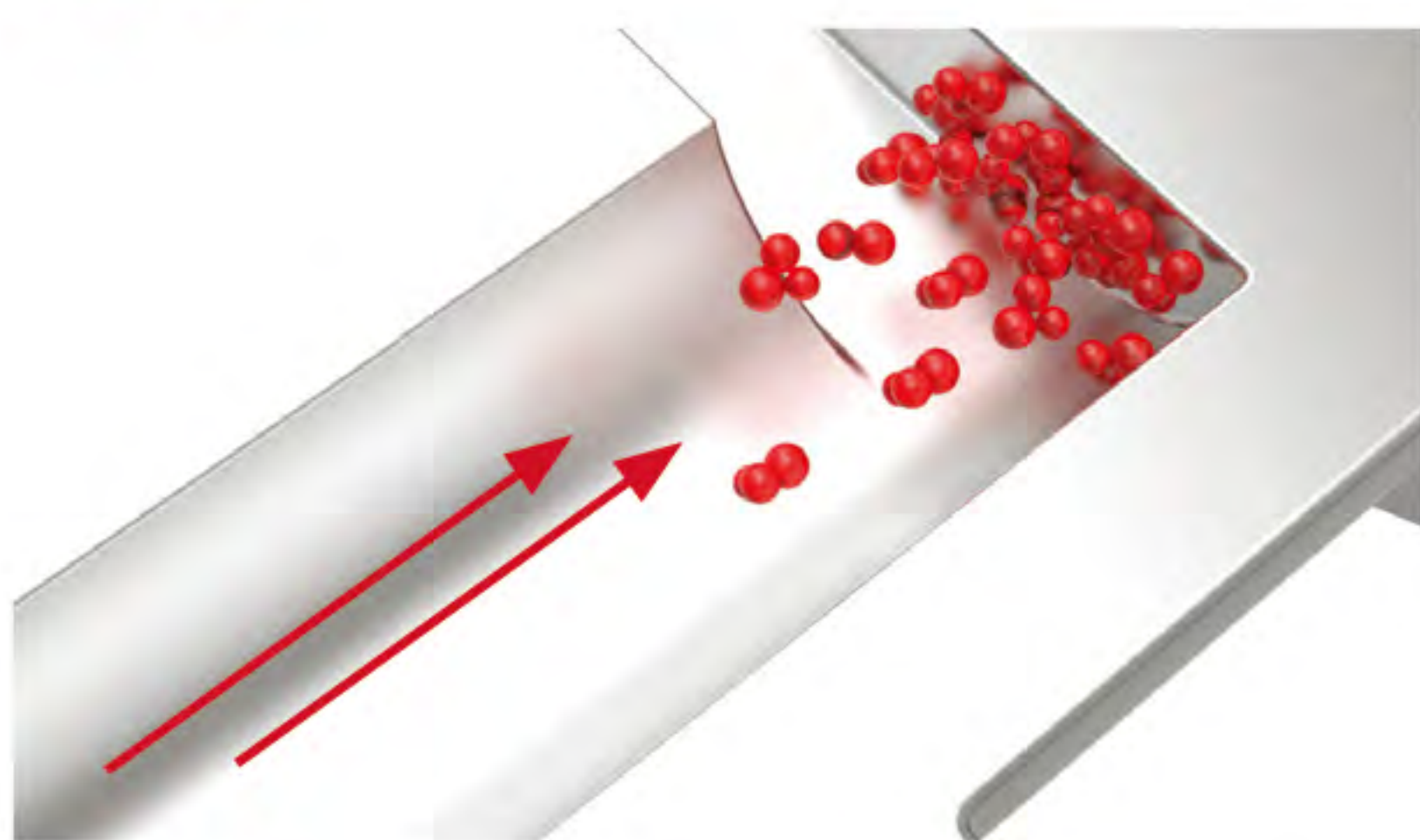

空化现象所造成的液体的相互碰撞及液体内部的颗粒流体发生碰撞而形成的碰撞力。

### 剪切力

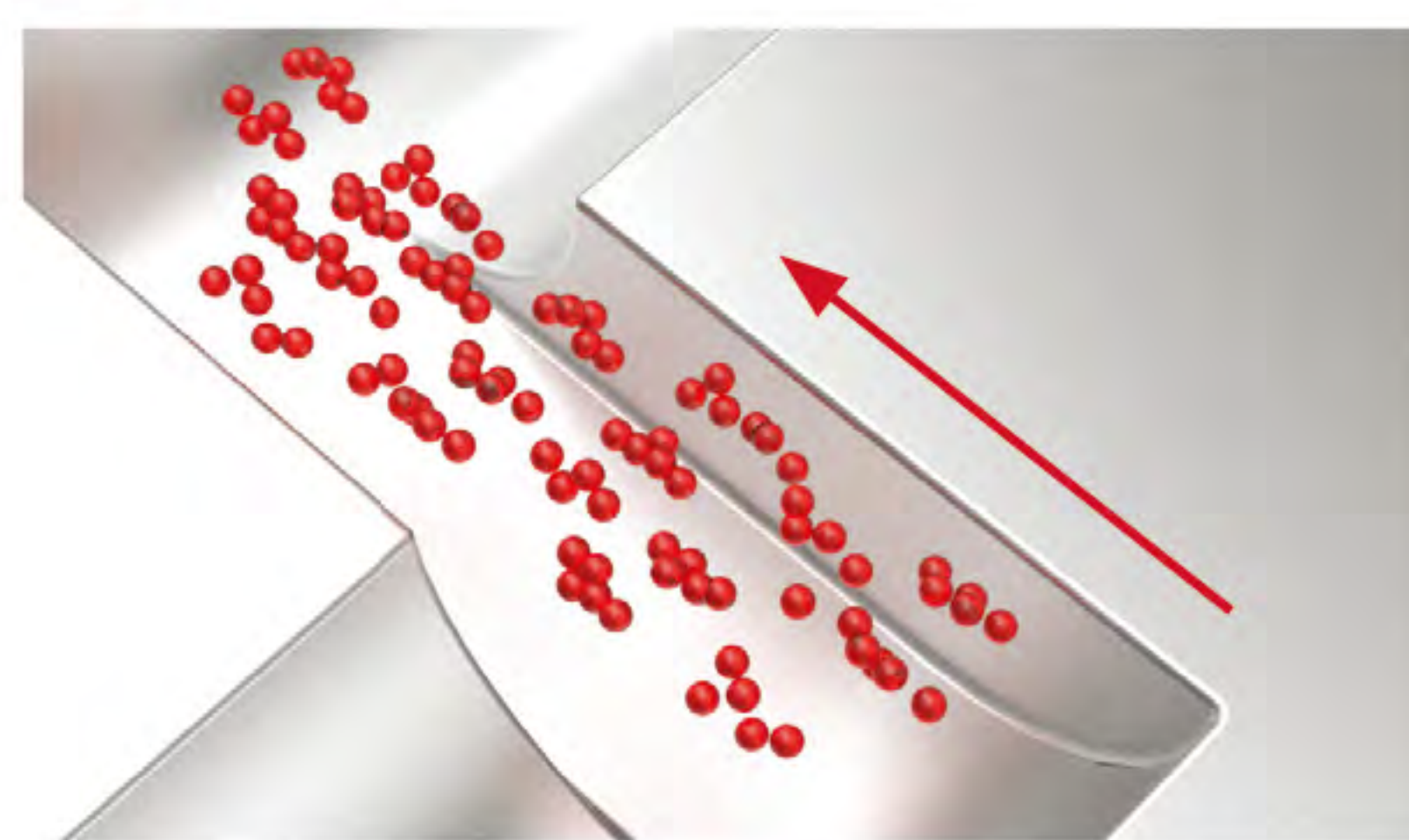

根据流体的表面张力及分散单元内部的壁面摩擦力, 粘度等, 会发生流体的剪切力。

### 空化

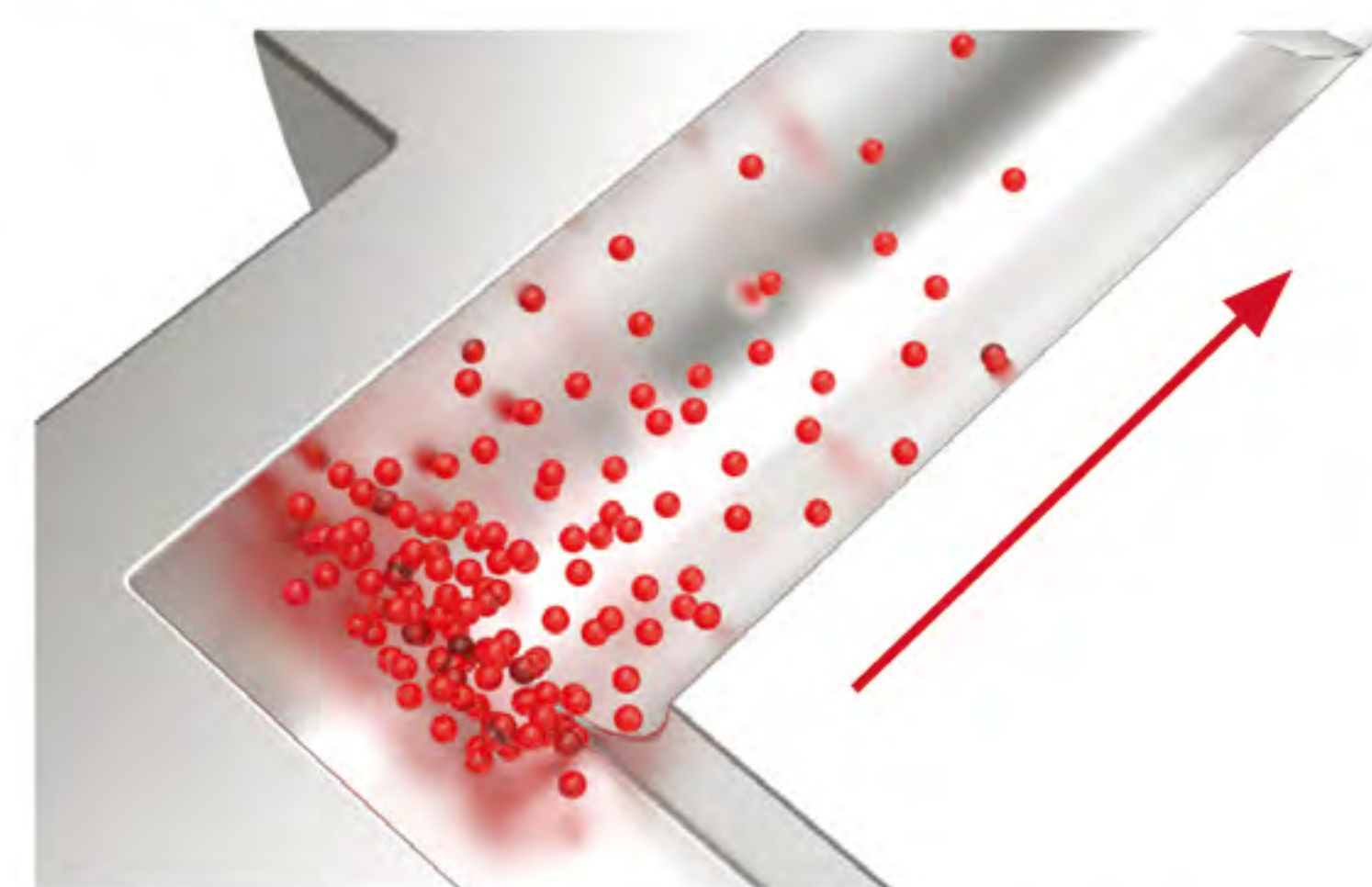

空化是指空隙的行为或气泡在液体中。如果速度增加, 则分子和空隙或间凝集力液体中的气泡迅速塌陷, 产生一种冲击波。

### IMPACT

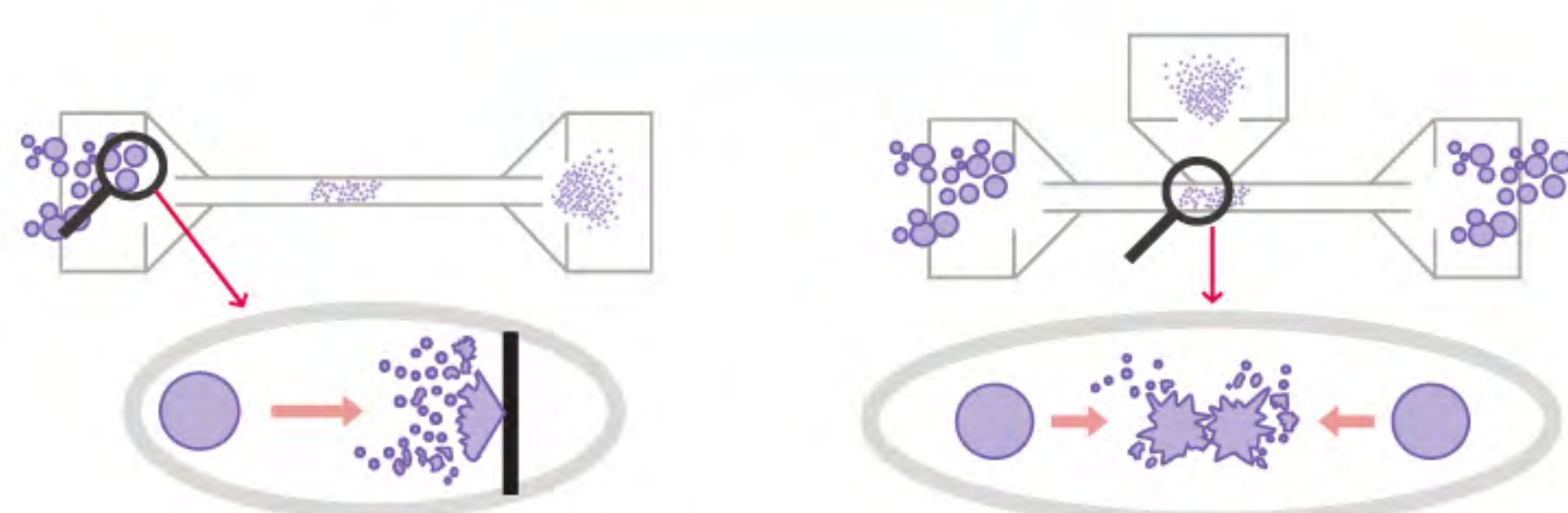

### SHEAR FORCE

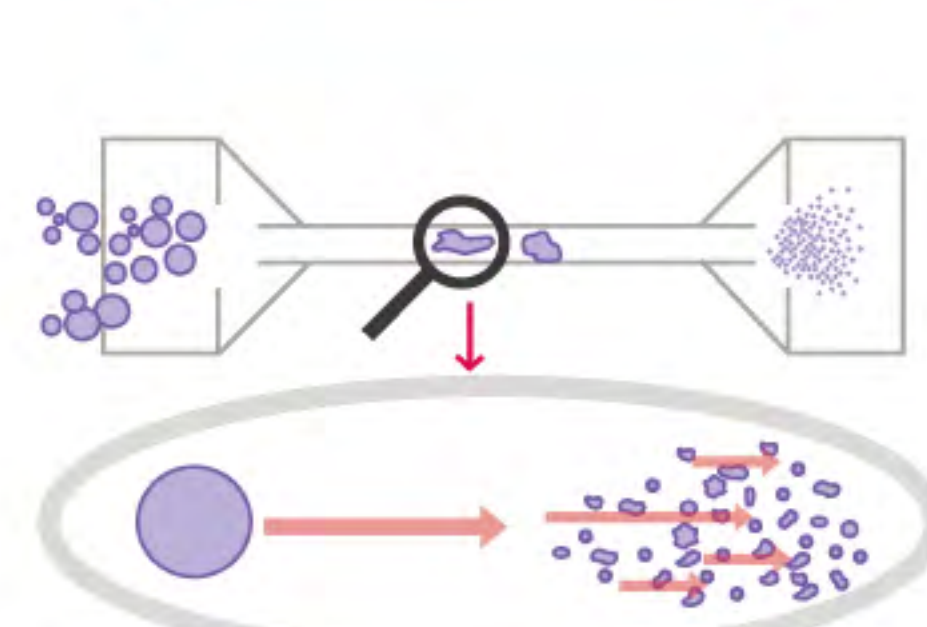

### CAVITATION

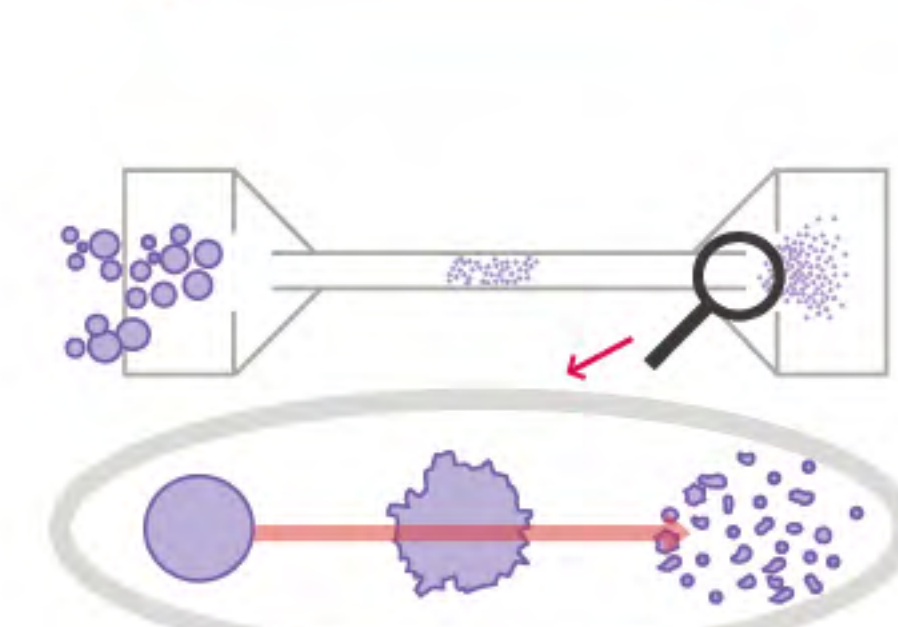



# Nano Disperser Application

## Electronics industry

### 电子工业

Multi Layer Ceramic Capacitor (MLCC)  
多层陶瓷电容器 (MLCC)



## Cosmetic / Nutraceutical

### 化妆品/营养食品

Omega-3 / Plant sterols / Vitamins  
Omega-3/植物甾醇/维生素



## Food

### 食品

Soy milk / Food colorings / Flavorings  
豆浆/食用色素/香料



## Pharmaceutical

### 制药

Injectables / inhalables / parenterals  
注射剂/吸入剂/胃肠外药物



## Biotech

### 生物

Cell disruption / Vaccines  
细胞破裂/疫苗

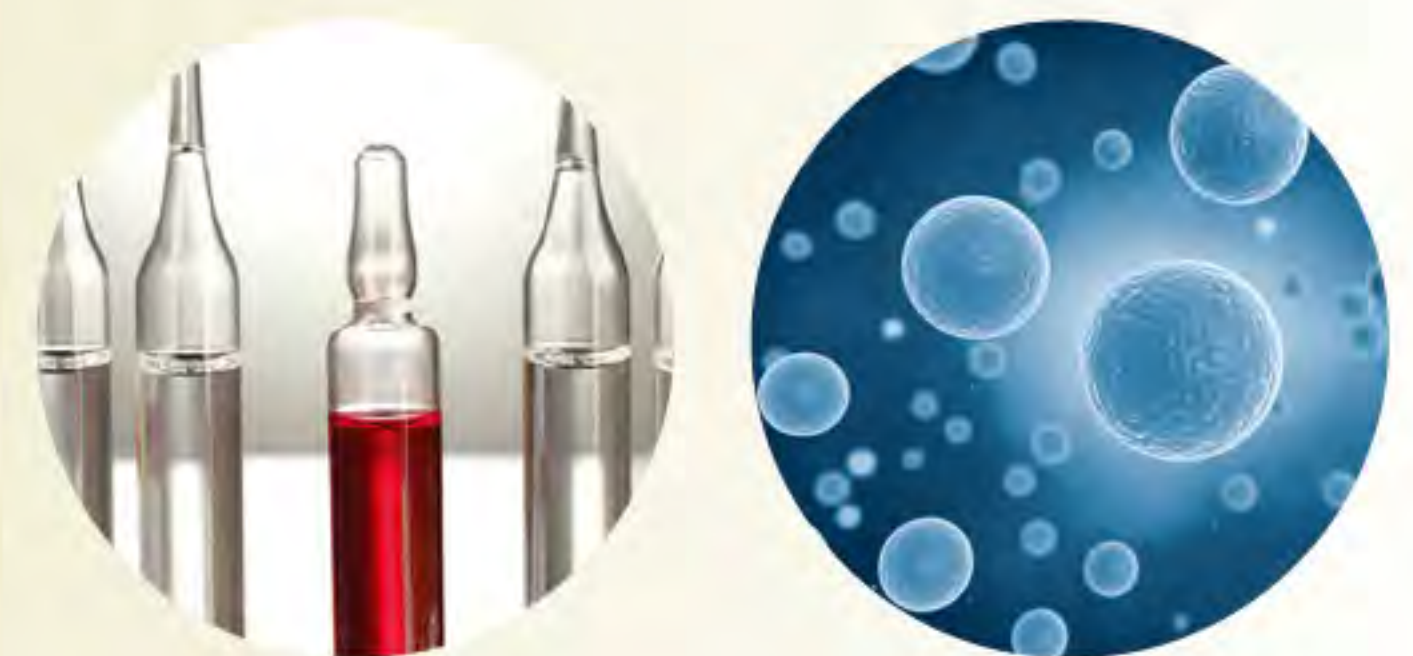

## Chemical

### 化学

Inks / Ceramics / Polymers / Carbon nanotubes  
油墨/陶瓷/聚合物/碳纳米管



Particle size reduction

- Emulsions
- Suspensions
- Liposomes

Cell disruption

- E-coil
- Yeast

Nano-encapsulation

- Polymers
- Liposomes
- Emulsions

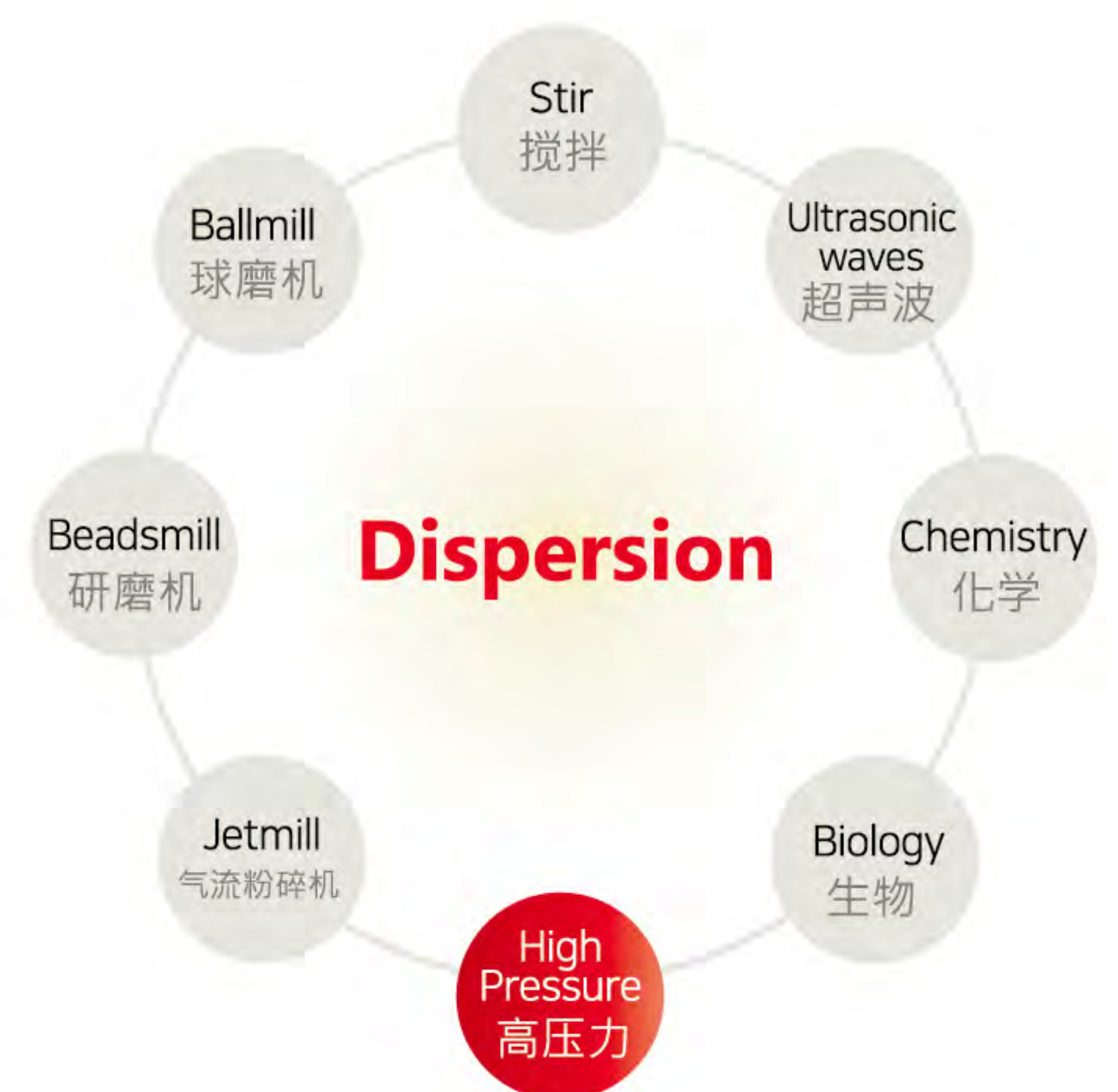
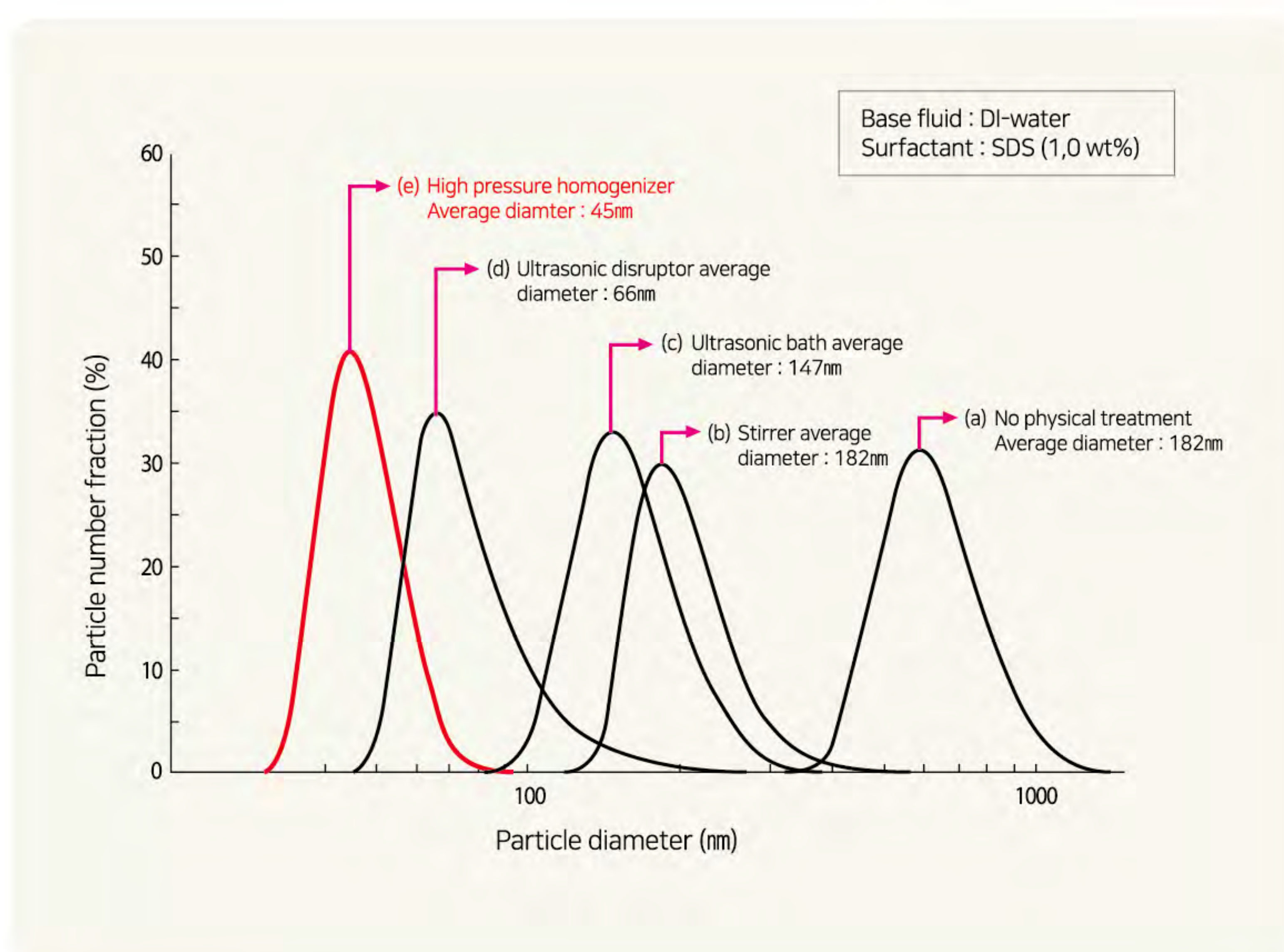



# 10-21p

# High pressure processing operation



web site : [hpp.co.kr](http://hpp.co.kr)





# HPP (High Pressure Processing Operation)

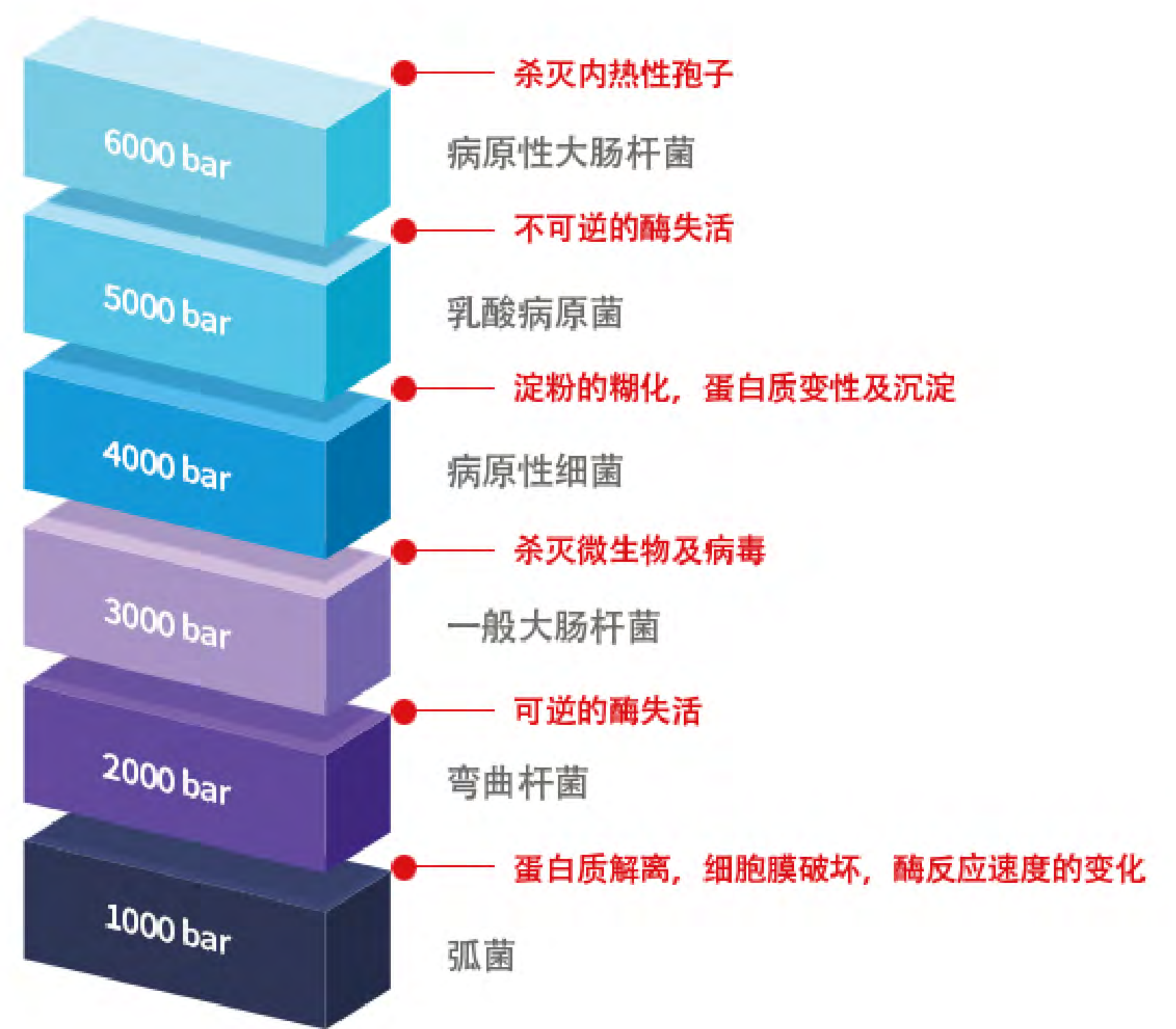
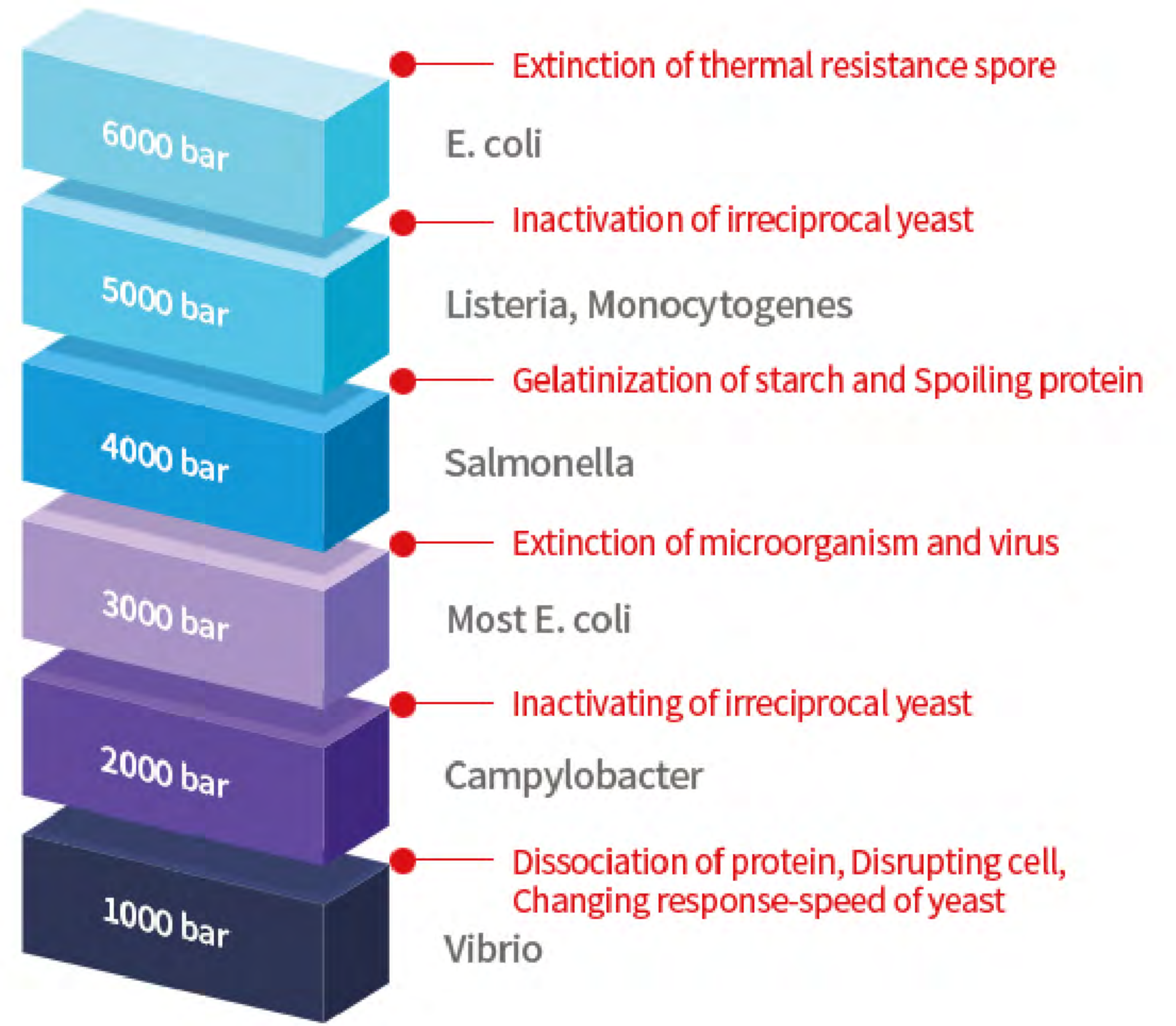



## HPP(High Pressure Processing Operation)

---

### HPP(High Pressure Processing Operation)

HPP(High Pressure Processing) could maintain favor and nutrition, and extend expiry date without heating or preservative.

That is eco-friendly technology that could not only sterilize also maintain quality of food without damage of nutrition.

这是一项突破性技术，延长保质期，无需热处理和防腐处理，同时保持食品的营养成分，口感和香味。

这是一种环保型的食品灭菌工艺，作为一种保持食品质量而不破坏营养素的技术而备受关注。

### Benefit of HPP

1. Extending expiry date as inactivating microorganism and yeast
2. Maintaining freshness for non-heating.
3. Protecting from second pollution as sterilizing with finished product
4. None compound and by-product for eco-friendly processing
5. Maintaining flavor and nutrition of original food supplies
6. Controlling microorganism according to change of pressure
7. Taking on mass production for short and simple processing

### HPP的特点

1. 失活微生物及酶，延长保质期。
2. 通过非加热工艺，维持新鲜的品质
3. 成品状态下进行灭菌，而防止二次污染
4. 通过环保型工艺，不会产生化合物及二次衍生物
5. 维持原材料原有的口感，香味，营养素
6. 跟随压力变化的微生物可控性
7. 处理时间短而简单，可以大量处理



## Application of HPP HPP的应用

HPP technology would be not limited by size or shape of products. So, HPP could be applied for various food processing area such as meat, seafood, vegetable, fruit and juice.

HPP(High Pressure Processing Operation)

超高压处理技术不受产品大小及形态的制约, 可应用于肉类, 海产品, 蔬菜, 水果, 果汁等各种领域。



### Juice / Fruit Smoothie / Coffee

2-3 minutes on 5,500 bar  
-Extending expiry date without damage of flavor and nutrition

生鲜果汁/果物冰沙/咖啡

5500bar 2~3分钟  
-无损失口感和营养成分 (维生素), 并且延长保质期



### Fruit / Vegetable

2-3 minutes on 5,500-6,000 bar  
-Maintaining freshness

果物及蔬菜

5500bar 2~3分钟  
-维持30日以上的的新鲜口感和香味



### Meat

5 minutes on 4,000-5,500 bar  
-Sterilizing food poisoning substance and toxic substance  
-Extending expiry date more than 90 days

肉类

4000~5500bar 5分钟  
-食中毒及有害菌的灭菌处理  
-维持90日以上的保质期



### Fish / Shellfish / Crustacean

Peeling: Under 3 minutes on 3,000 bar  
-Increasing productivity without damage of nutrition

Sterilizing: 4,000-6,000 bar  
-Extending expiry date by sterilizing

鱼贝类及贝壳类

脱壳: 3000bar 3分以内  
-无破坏营养成分, 并且节减成本及增加生产性  
灭菌: 4000~6000bar  
-通过灭菌延长保质期



### Processed Food

2 minutes on 5,000-6,000 bar  
-Preserving the original quality, Extending expiry date more than 30 days

加工食品

5000~6000bar 2分钟  
-保持原有品质, 延长保质期30日以上

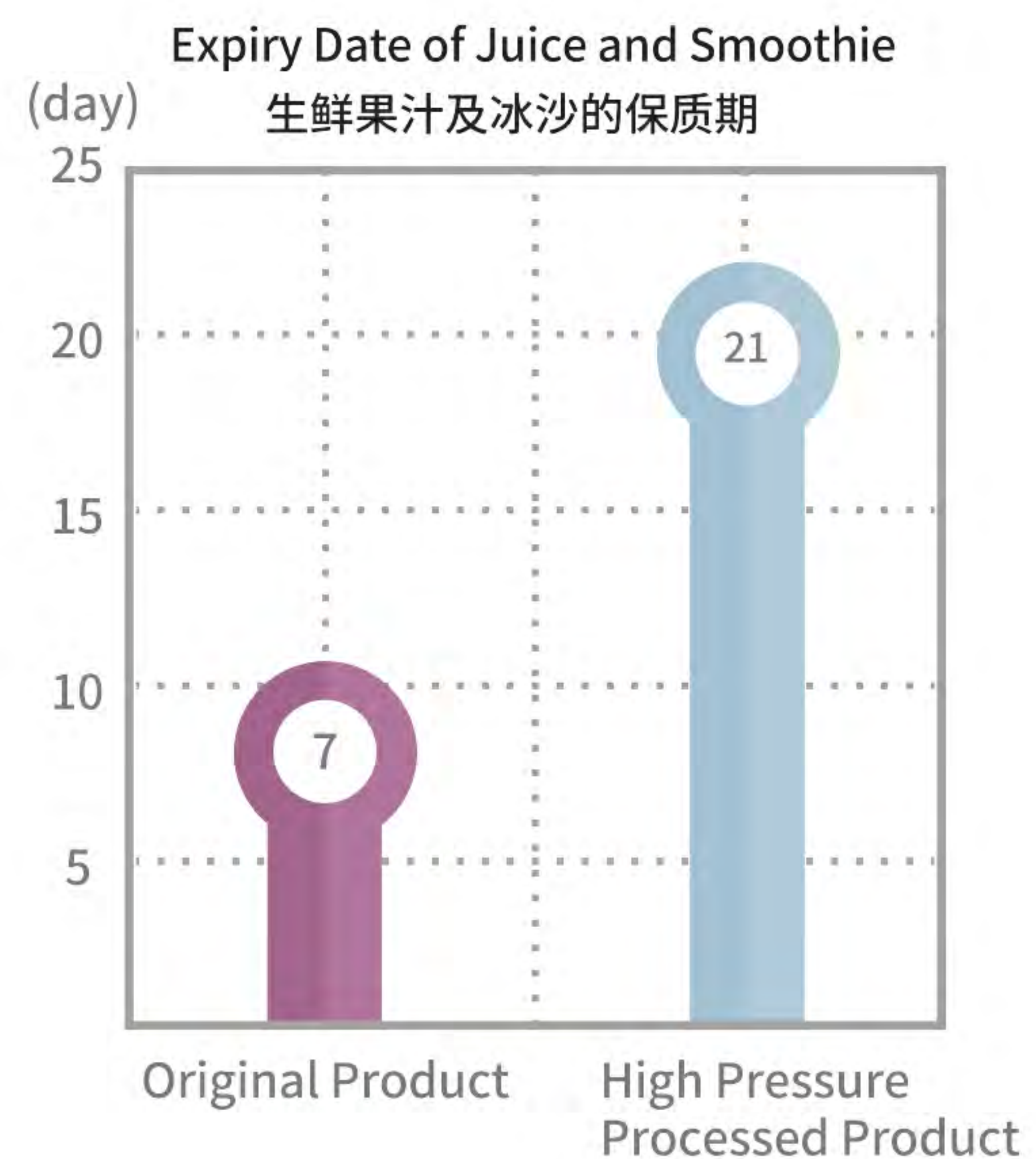



## Application of HPP HPP的应用

### Juice & Beverage

Many companies try to extend the expiry date of their products such as juice and beverage by preservative and chemical material. Until recently, the chemicals in beverage often have been the cause of many lifestyle diseases. HPP could solve these problems, and extend expiry date about 2-3 times.

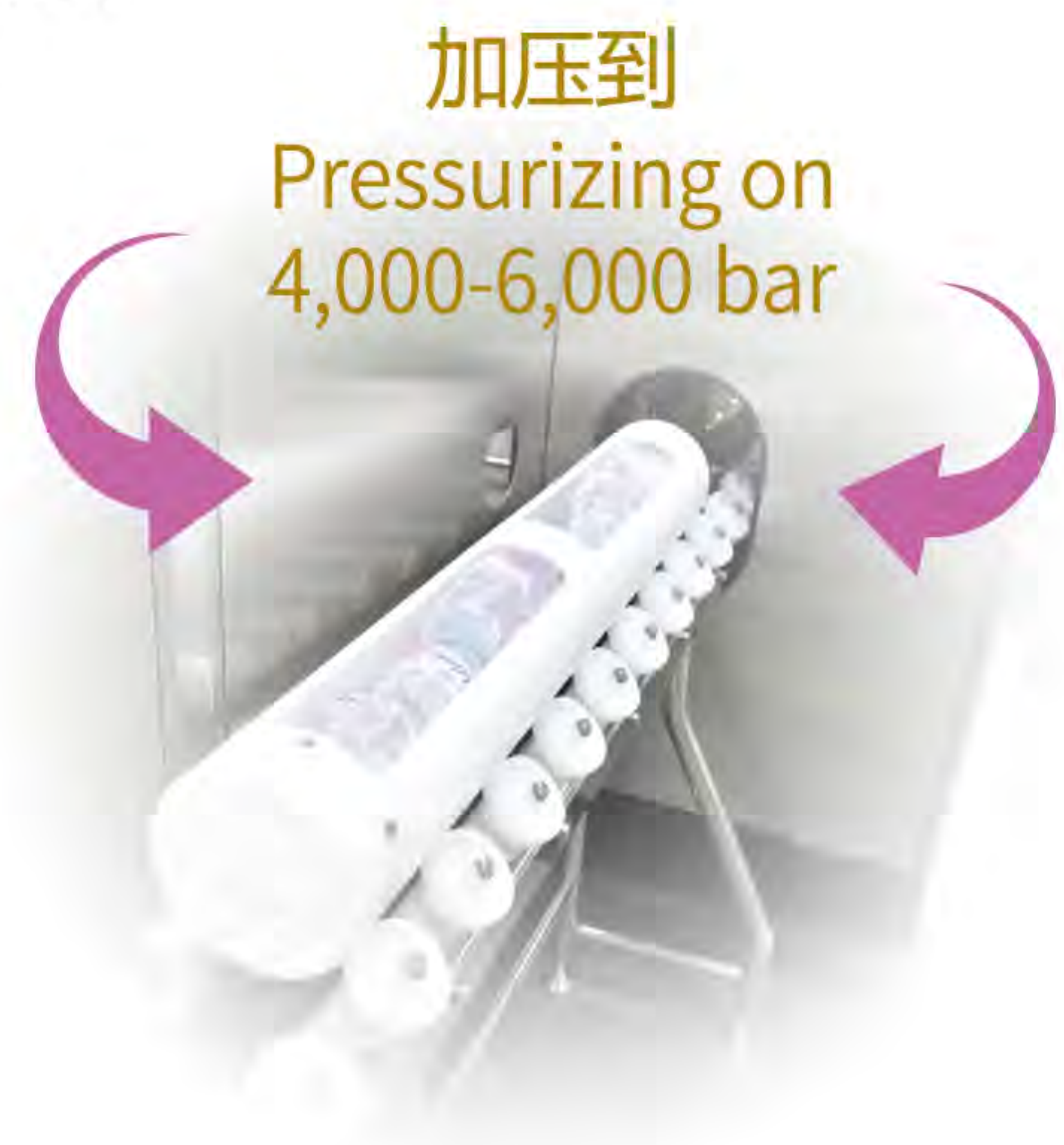

### 果汁和饮料

许多饮料生产公司试图通过防腐剂和化学材料延长他们的产品如果汁和饮料的有效期。直到最近，饮料中的化学物质一直是许多成人病及其他疾病的原因。HPP可以解决这些问题，并且延长保质期约2-3倍。

### Extending Expiry Date

When you load packed beverage into the container and pressurize it for 1-10 minutes on 4,000-6,000bar, bacteria and toxic substance would be extincted so the expiry date could be extended about 2-3 times. That is eco-friendly technology because it maintains flavor, color and shape without chemicals and heating.

### 延长保质期

将包装好的饮料装入容器中并在4,000-6,000bar的压力下加压1~10分钟时，细菌和有毒物质将灭绝，因此保质期可延长2-3倍。这是一种环保技术，因为它保持了原有口味，颜色和形状，没有化学品和加热等原因造成的变性。

### Various Applications

#### 根据使用目的各种应用技术

| Applicable Food According To Pressure and Temperature<br>压力及温度别适用食品 |  |  |
|---|--|--|
| Category<br>类型  | Specification<br>规格  | Applicable Food<br>适用产品  |
| Sterilizing on High Pressure and Low Temperature<br>高压, 低温灭菌法       | 4,000~6,000bar / Normal Temperature<br>4,000 ~ 6,000 bar / 常温    | Juice, Smoothie, Beverage, Processed Food<br>果汁, 冰沙, 蔬菜混合物, 加工食品 |
| Sterilizing on Ultra High Pressure and Heating<br>超高压兼加热灭菌法         | 7,000~9,000bar / 80~120°C  | Vegetable, Processed Food<br>蔬菜, 加工食品                            |
| Freezing and Defrosting on High Pressure<br>高压冻结及解冻法                | 0~2,000bar / Normal Temperature<br>0 bar~ 2,000 bar / 常温         | Piece of Fruit, Vegetable<br>切块果物, 蔬菜                            |
| Infiltrating on High Pressure<br>高压细胞渗透法                            | 1,000~2,000bar / Normal Temperature<br>1,000 bar~ 2,000 bar / 常温 | Extracting Vitamin<br>维生素萃取                                      |
| Changing on High Pressure<br>高压产品变形法                                | 5,000~7,000bar / (Changeable)<br>5,000 bar~ 7,000 bar / (根据产品可变) | Fruit Jam, Vegetable<br>果酱制作过程, 蔬菜的形态变化                          |



## Application of HPP HPP的应用

### Sterilizing on High Pressure and Low Temperature

HPP extirpates microorganism and yeast on 4,000-6,000bar and normal temperature. So, it could maintain freshness of products, Once you maintain specific pressure for 1-10 minutes, you could extend expiry date of product more than 30 days.

### 高压, 低温灭菌法

HPP在4,000-6,000bar的常温下消灭微生物和酵母菌, 因此可以保持产品的新鲜度。产品在不使用化学防腐剂和工艺, 只在适当的高压条件下维持1~10分钟, 有效延长保质期30日以上。



### Sterilizing on Ultra High Pressure and Heating

To apply this technology to HPP, you have to heat product on 70-90 degrees, and pressurize on 8,000bar. When you pressurize on targeted pressure, the temperature of product would be increased up to 120 degrees. These processing would be continued for 3 minutes. So, the expiry date would be extended more than 30days on the condition of freezing.

### 超高压兼加热灭菌法

要将此技术应用于HPP, 您必须将产品加热至70-90度, 然后加压至8000bar。当在目标压力下加压时, 产品的温度会增加到120度。这些处理时间将持续3分钟。因此, 在冷藏保管情况下, 保质期将延长30天以上。

### Freezing and Defrosting on High Pressure

This is ice-manufacturing method by thermal losses which is happened as pressure about 2,000bar is depressurized rapidly. It could freeze the product. So, purpose is for quick-freezing, equalizing degree and preserving shape. It could be applied for vegetable and fruit. It is outstanding for preserving shape of product.

### 高压冻结法

高压冷冻是由于快速降低约0~2000bar的压力而产生的热量损失而制造冰粒的方法, 这种方法可以使每种产品具有均匀的冷冻效果。此方法的主要目的是, 1: 急速冷藏, 2: 产品温度的均一性, 3: 保存产品的形态。它可以应用于蔬菜和水果, 对于保存产品的形态比原有的方法更安全, 迅速, 并且有卓越的效果。



### Infiltrating on High Pressure

It could crystallize cells on 1,000-2,000bar, so it could extract ingredients inside. It could be applied on lower pressure(1,000-2,000). And the purpose of the technology is for extracting ingredients inside such as vitamin in vegetable and fruit.

### 高压细胞渗透法

它可以在1000-2000bar压力的条件下达到细胞的结晶化, 提高细胞内部的透过率, 因此可以提取里面的有效成分。加工工艺不同于其他方法, 在低压环境下实现 (1000~2000bar), 具有产量高, 提取产品内部的有效成分而广泛用于研究目的。多用于蔬菜, 水果等含有维生素制品的提取。

### Changing on High Pressure

It could be realized on high pressure about 5,000-7,000bar. It is used for gelatinizing of starch and protein, and changing property to pectin. It is also used for lower sterilizing and pre-heating so that could maintain freshness and extending the expiry date.

### 高压产品变形法

“高压产品变法”适用于产品的形状和性能改良, 在5000~7000bar的高压下进行, 用于淀粉和蛋白质凝胶变形, 如同果酱产品主要成分的“pectin”它也被用来改变属性而使用。该工艺用于产品的巴氏消毒灭菌和预热目的, 保持产品的新鲜度, 增加安全性和保质期。



## Application of HPP HPP的应用

### Meat

HPP is chosen for the most safe food processing in United States Department of Agriculture (USDA) & Food Safety and Inspection Service (FSIS). It could extend the expiry date and maintain the original flavor and color.

Also HPP is acceptable for almost product without the limit of size, shape, weight and volume. After Raw whole meat or Sliced product packed with plastic is vacuum-packed and loaded on HPP container, it is pressurized on high pressure.

At that point, the shape of the product would be not transformed because it is pressurized in all direction.

### 肉类

HPP被选为美国农业部 (USDA) 和食品安全检验局 (FSIS) 最安全的食品加工。它可以延长保质期并保持原有的风味和色泽。对于产品的尺寸, 形态, 重量和体积几乎没有限制, HPP可以处理大多数产品。用塑料真空软包装并装载到HPP容器后, 在高压下进行加压。此时, 产品所受的压力是同等方向的等静压, 所以不会发生产品变形。

### Extending The Expiry Date

When packed meat is pressurized on 200-600MPa for 1-5 minutes, the microorganism and pathogenic fungus would be extincted so the expiry date would be extended more than 2-3 times.

### 延长保质期

当包装肉在200-600Mpa加压1~5分钟时, 微生物和病原真菌就会灭绝, 保质期将延长2-3倍以上。

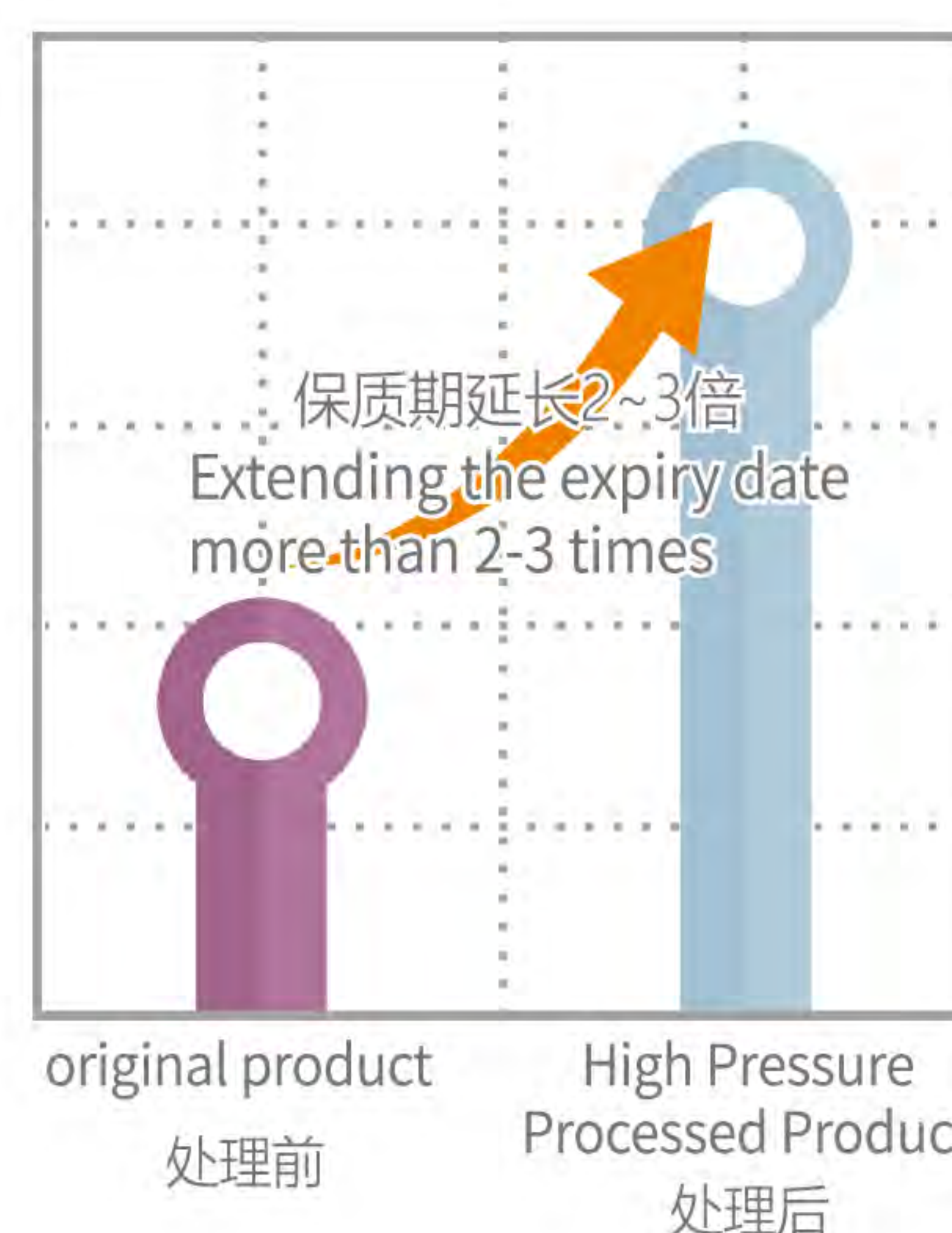

### Various Applications 各种应用

#### Raw whole meat

You could extend the expiry date without any changing quality or property.

It is safe because of using water and electricity.

And you could modify the purpose according to pressure degree.

家畜的肉制品不改变肉的原始质量的情况下延长保质期。HPP以简单安全的水电方式驱动, 保持肉质和新鲜度, 并且可以比传统方法延长2~3倍的保质期。根据操作压力的不同, 使用目的可多样化。

| No. | Product<br>产品名 | Purpose<br>使用目的                  | Pressure<br>工作压力 |          | Maintaining Time<br>维持时间 |
|-----|----------------|----------------------------------|------------------|----------|--------------------------|
| 1   | Meat<br>生鲜肉    | Extending the expiry date<br>保质期 | 4,000bar         | 6,000bar | 5min                     |
| 2   |                | Fleshiness<br>肉质                 | 2,000bar         | 4,000bar | 1-5min                   |
| 3   |                | Diminishing waste<br>减少废弃物       |                  |          |                          |

Isostatic Pressure which is among HPP technologies could diminish the waste that is released during unfreezing. It pressurizes the product so it could sterilize any fungus. In other words, it does not need post-processing and you can save your budget.

HPP技术中的等静压可以减少解冻过程中释放的废物。它对产品加压, 以便灭菌任何有害菌。换句话说, 它不需要后处理, 可以节约成本。



## Application of HPP HPP的应用

### Sliced & Diced

If you sterilize sliced meat, you would go through the trouble as the shape and volume of the meat.  
HPP technology is applied almost product without the limit of shape and weight.



### 研磨及初级加工肉制品

精细研磨的初级加工肉通常由于形态和体积而成为二次加工 (杀菌) 的问题。  
HPP技术不受形态, 尺寸, 重量的限制而方可应用。

### Dry & Cured Meat

HPP technology would not damage the ingredient of product so it could offer high quality product.  
And you could diminish salmonella and listeria by HPP technology 8 times more which are food poisoning bacteria.



### 肉干及熟食

HPP技术与传统的热灭菌方式不同, 不会损坏产品颗粒, 也不会产生新的衍生物, 因此可以为消费者提供更高质量的产品。  
通过使用HPP技术, 沙门氏菌和李斯特菌等细菌在肉类干燥过程中可能发生的食物中毒细菌数可减少8倍。

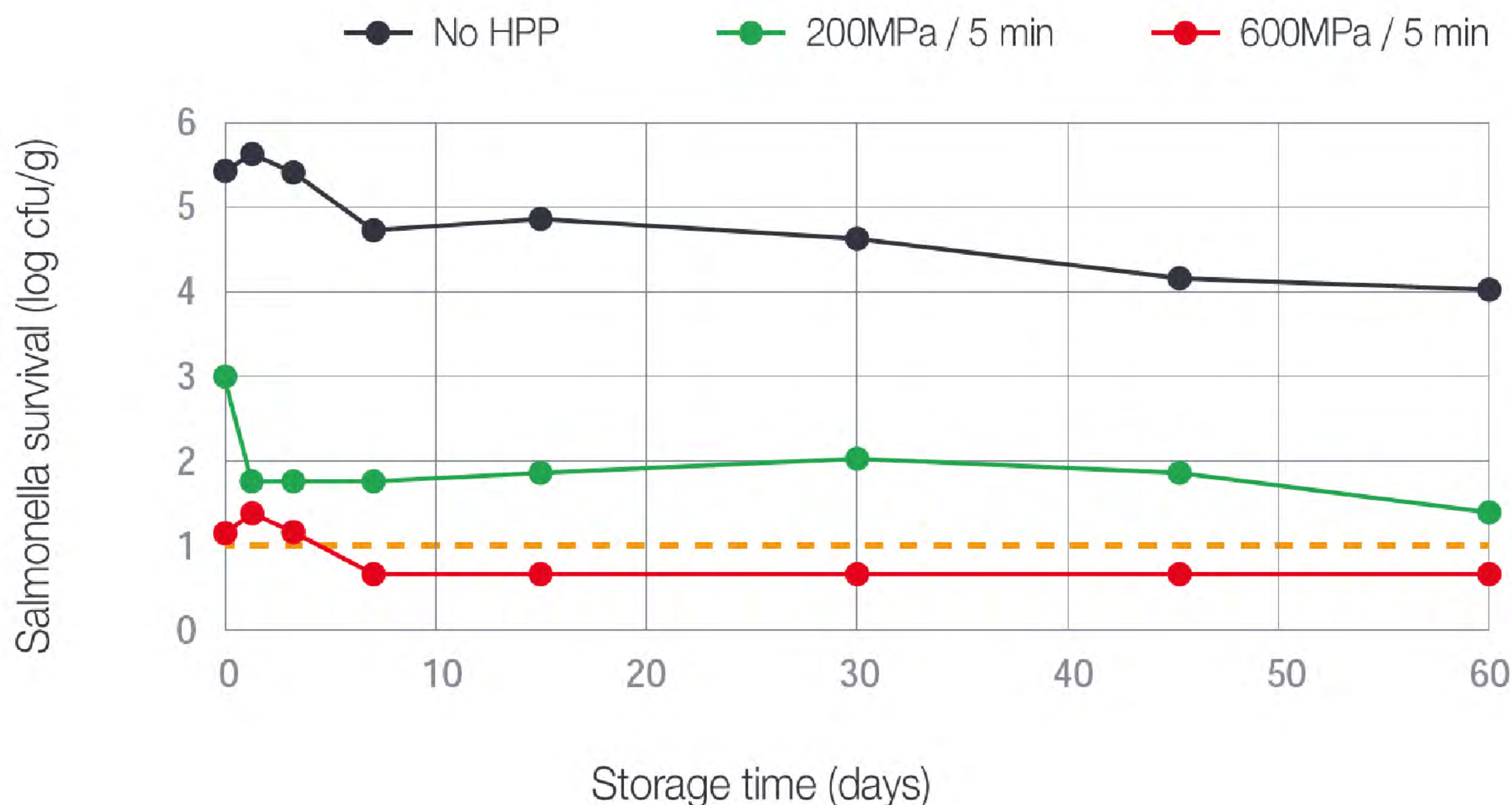

### Conclusion

HPP technology would not damage the ingredient of product so it could offer high quality product.  
And you could diminish salmonella and listeria by HPP technology 8 times which are food poisoning bacteria.

### 结论

HPP技术是一种“新”食品加工技术, 对人体无害, 保持肉的原始新鲜度和质量, 除上述产品外, 还可将HPP技术与各种产品相结合。



## Application of HPP HPP的应用

### Ready to Eat

According increasing the customers who want to have meal conveniently, HPP technology is being applied to various area. Because you do not need to freeze after processing, the flavor and freshness of the product would be maintained.

The fruit would be difficult to re-pack after unpacking for processing. But HPP technology is acceptable for packed product, so you do not need to unpack your product.

### 即食

随着消费者越来越希望以简单的方式享用他们的餐食, 他们被认为已将HPP技术应用于各种食品。由于我们不会在烹饪后餐食进行冷冻, 而能够为消费者提供保持原有新鲜度和口感的食品。

最重视新鲜度的蔬果产品很难重新包装使用。可以应用HPP技术而不受包装条件的制约, 其中还包括由水果和蔬菜产品制成的饮料。

### RTE(Ready to Eat) Products.

HPP technology is applicable for all ready-food including meat, fish, fruti and vegetable. That could extend the expiry date and maintain the original quality of the product. These products would be pressurized on 5,000-6,000bar and low temperature. HPP technology is applied last packing process, so you do not need to pack your product additionally.



### RTE (即食) 产品。

HPP技术可应用于已加工成肉, 鱼, 水果, 蔬菜和蔬菜的所有“即食”食品。除了能够安全地延长我们产品的保质期外, 如同家中刚刚煮熟后的餐食保持原有的质量。这些产品在5,000~6000bar的压力和冷藏温度下进行加工。HPP技术用于所有产品的最终包装阶段。这是非常经济性的, 因为加工后不需要额外的包装。

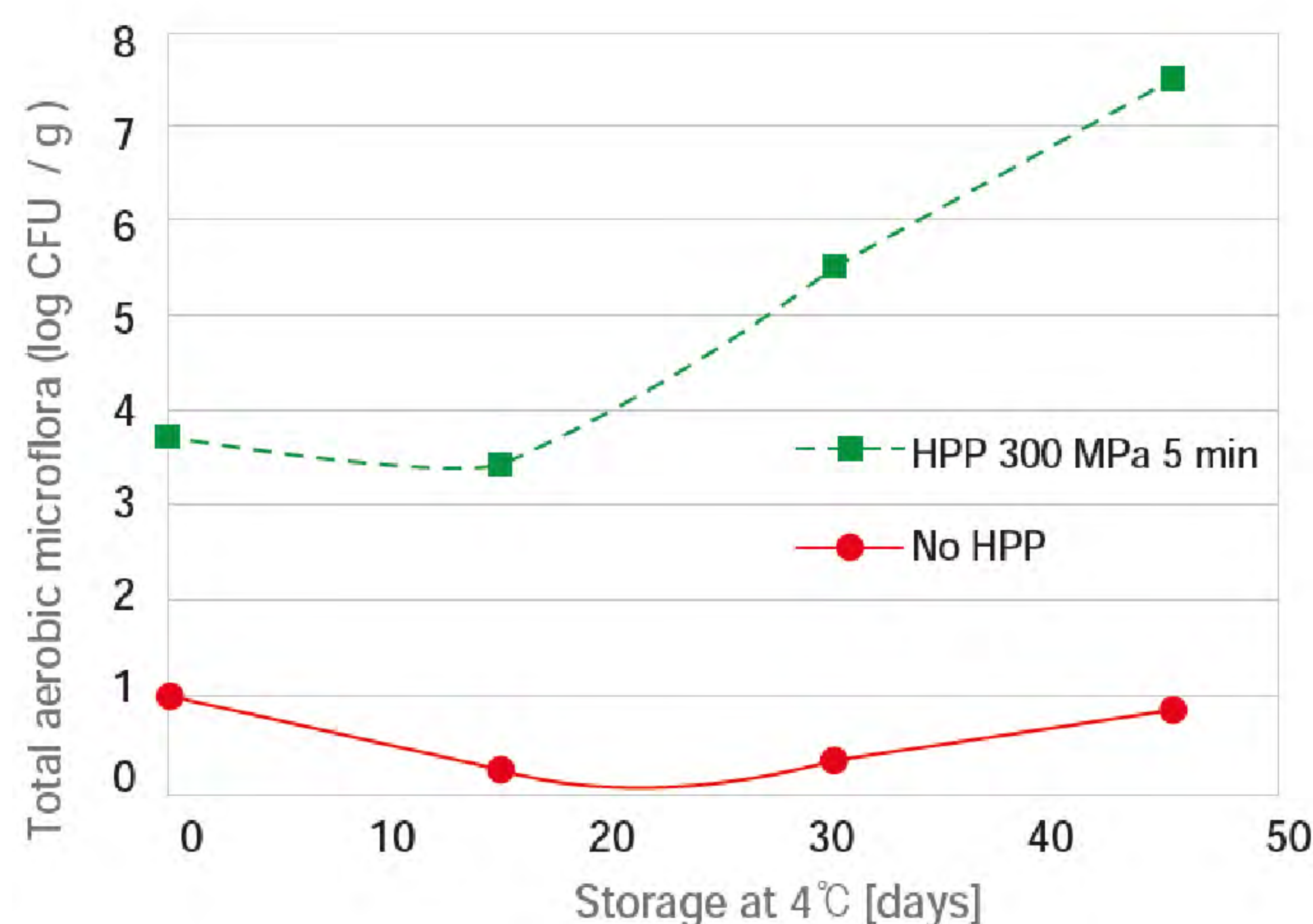

### Safety

HPP technology extincs any food poisoning bacteria and pathogenic fungus safely and efficiently. So, you do not need a chemical preservative for extending the expiry date and maintaining the original quality.

### 安全

HPP技术对RTE食品最重要的优势之一是能够安全有效地清除引起食物中毒的病原体, 从而保持产品质量并延长保质期, 并且最小化使用化学成分。



## Application of HPP HPP的应用

### Cold Storage

Various fungus which happen food poisoning or other disease could inhabit in RTE food.  
If you use HPP, you have to consider the property of product, pressure, temperature and ph degree.  
The lower ph degree is, the lower microorganism inhabit.  
HPP could not eradicate, but restrain the microbic activity.  
So, RTE food have to be cold storage.

### 冷藏保管

在RTE食品中, 各种成分混合在一起, 食物中毒和其他疾病, 它可以提供各种可能导致致病微生物的各种环境条件。  
当使用HPP压缩技术时, 产品的特性和操作压力, 温度, 酸度 (pH) 是最重要的作用。  
事实上, 可以证实pH越低, 微生物的活性越低, 活性和生殖越低。  
虽然HPP可以抑制微生物的活性, 但它不能根除所有的微生物。  
因此, RTE产品应始终存放在冰箱中。

### Expiry Date

According to Rovere et al. 2006, the expiry date of rice and mushroom would be extended above more 45days.  
There is the test report below which processed rice and mushroom by HPP have been maintained on 4 degree.

### 保质期

根据Rovere et al的2006年研究的结果, 估计韩国人主食 (如大米和蘑菇) 相比可以将其保质期延长约45天, 结果很好。  
以下图表显示了HPP在4°C下加工的大米和蘑菇家禽的保鲜实验数据。

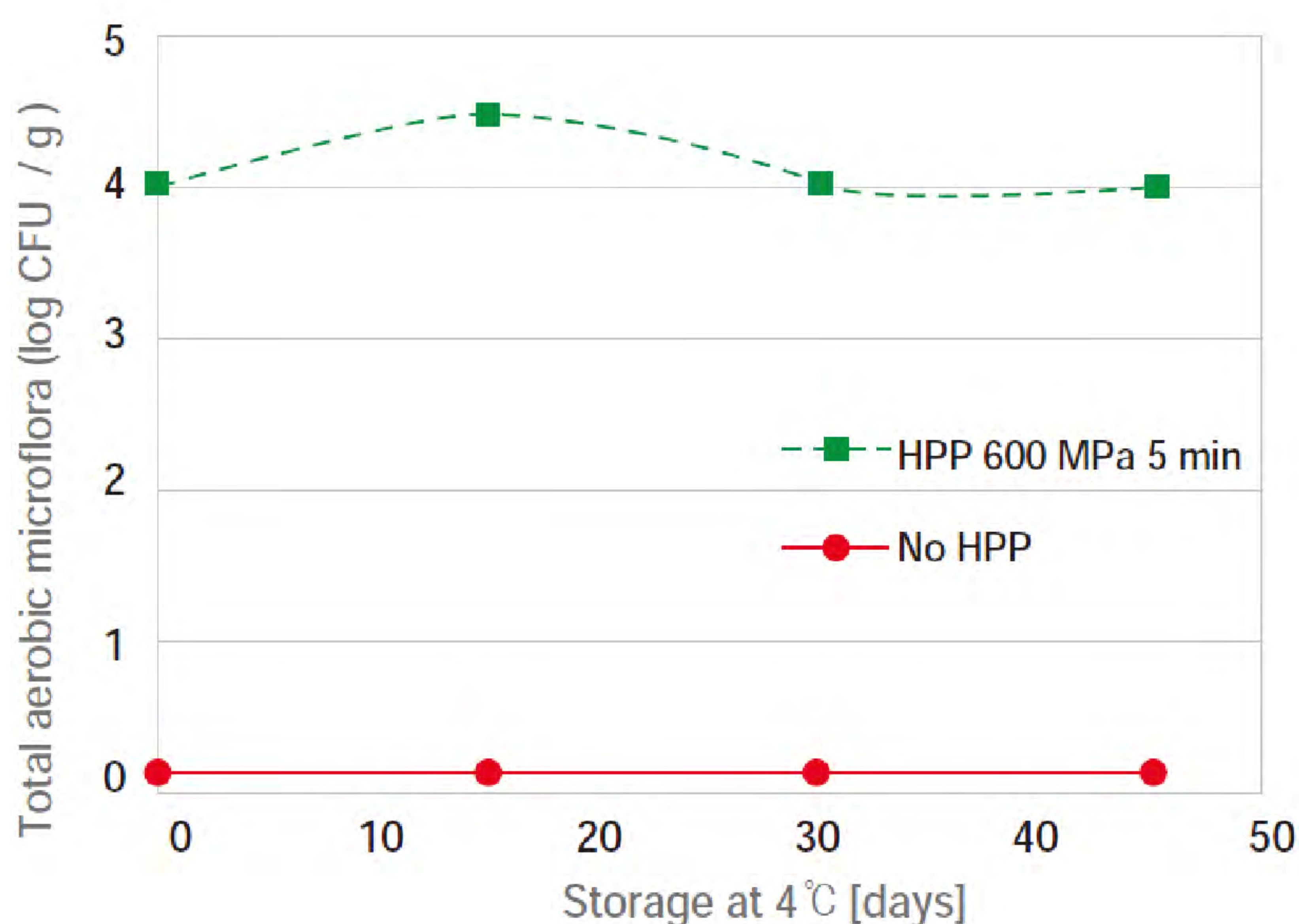

### Conclusion

The acceptance of HPP for Ready to Eat product has been continuous since 2007.  
Recently many processing companies try to find applications which they could apply HPP technology.  
HPP technology uses electricity and water, and reuses used water for operating.  
So you do not need to waste some material. In other words, it is economic and eco-friendly machine.

### 结论

根据记录, 自2007年以来, HPP即食产品应用已得到确认。  
许多食品加工公司已经认知到HPP的重要性, 并且努力寻更多的应用产品。  
使用电力和水, 用过的水被重复使用, 以最大限度地减少机器产生的废水。  
HPP技术能够为消费者提供对环境无害的安全食品, 并最大限度地减少食品安全问题的发生。



## Application of HPP HPP的应用

### Oyster / Shellfish

HPP could peel the shell of oyster and shellfish under 3,000bar.

When you use HPP for peeling, the flesh which could open and close the shell is not shrunk. So the peeling is so easy. And because the higher productivity increases, the lower workforce is.

### 牡蛎/贝类

如果使用HPP技术给牡蛎和贝类加压3000bar以内的压力,将无法收缩外壳开闭肌而易于脱壳。因此, HPP设备可以轻松加工,以提高产量并减少劳动力,从而节省成本。



### Lobster / Crab

If you need to peel the shell of lobster and crab, you could peel the shell by HPP easily. Through this processing, you could offer the peeled lobster and crab to many consumers which have trouble to peel the shell of the lobster and crab.

### 龙虾/螃蟹

如果甲壳类,如龙虾和螃蟹使用HPP超高压处理,可以很容易地剥离甲壳。通过这一过程,我们能够为消费者提供难以剥离的新鲜且易于烹饪的贝类。

## Conclusion

You could obtain the flesh from shellfish and lobster. The lower cost of production is and the higher efficiency is. Also, HPP technology could extend expiry date without damage of ingredient. HPP could inactivate listeria, salmonella and vibrio so you could offer the fresh and safe food to consumers.

## 结论

因为可以像上述那样容易地从贝类或贝类中提取肉类,所以生产成本降低并且生产效率最大化。此外,我们能够延长我们产品的保质期,而不会破坏我们产品的营养成分,并为我们的客户提供安全的产品。据说HPP工艺在食品加工工业中是必不可少的,因为它可以通过使危险的食物中毒病原体(李斯特菌和沙门氏菌)和弧菌失活而安全的供应给消费者新鲜的食物。



## Application of HPP HPP的应用

### Fruits Products

The number of consumers that considering freshness of food carefully is increasing these days. So food processing companies try to find the way to extend expiry date and maintain the freshness.

### 水果产品

消费者越来越意识到食物的新鲜度。  
目前很多食品公司正在使用各种方法来延长保质期或寻找保存新鲜食品的方法。



### Safety

Because of polluted food and big issue for listeria and salmonella many consumers care about the safety of food processing. HPP processes products by using only hydraulic pressure without any preservative and chemicals. So we could offer fresh food without preservative and chemicals to consumers. Also, HPP technology could maintain the original flavor, color, mouthfeel and ingredient.

### 安全

由于涉及受污染的食品, 李斯特菌和沙门氏菌等是消费者食品安全的最大问题, 而且非常感兴趣。  
HPP是一种高压处理过程, 仅在水压下操作, 在不使用化学物质或防腐剂的情况下使微生物失活, 它有其独特的功能。  
因此, 我们能够为客户提供新鲜, 安全包装的水果和蔬菜产品, 而无需添加添加剂或防

### Conclusion

HPP technology could maintain the original flavor, ingredient, yeast without heating, chemicals and preservative.  
HPP technology could be applied to last packaging processing, so pollution by bacteria would be not appeared.

### 结论

它不需要化学物质或防腐剂就能满足消费者的需求, 具有新鲜, 美味和无营养的破坏性和安全性。  
它保持了被热处理破坏的维生素和酶作为一种冷处理过程。  
由于HPP用于产品的最终包装, 因此不存在危险细菌污染的风险。



# 22-27p Specification 规格

## Specification 规格

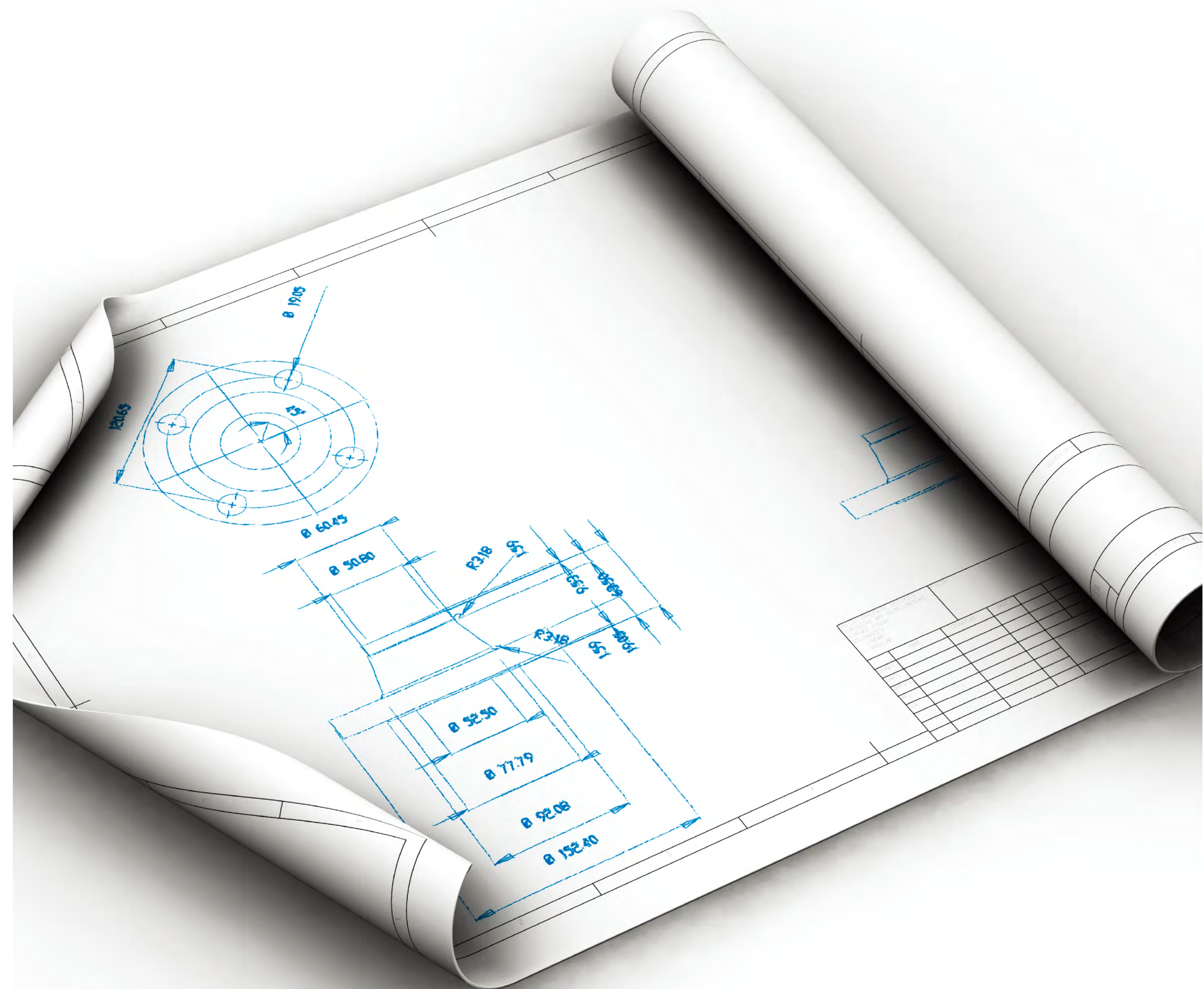



# Specification of Nano Disperser

## Specification 规格

### NANO DISPERSER (NLM 100)



|  |                                     |
|--|-------------------------------------|
| <b>Operating Pressure</b><br>使用压力 (最高压力) | 1,500bar [Max. 2,000bar]            |
| <b>Flow rate</b><br>流量                   | Max. 100ml/min                      |
| <b>Pump system</b><br>电机系统               | Motor driven type [220V, 1-ph, 1hp] |
| <b>Inlet reservoir</b><br>料杯容量           | 300ml                               |
| <b>Dimension</b><br>尺寸                   | 583(W)X576(D)X435(H)mm              |
| <b>Weight</b><br>重量                      | Approx. 45kg                        |
| <b>Interaction chamber</b><br>分散单元规格     | 75/100µm<z/y type>                  |

### NANO DISPERSER (NH 500)



|  |                          |
|--|--------------------------|
| <b>Operating Pressure</b><br>使用压力 (最高压力) | 1,500bar [Max. 2,000bar] |
| <b>Flow rate</b><br>流量                   | Max. 500ml/min           |
| <b>Pump system</b><br>电机系统               | Hydraulic unit system    |
| <b>Inlet reservoir</b><br>料杯容量           | 2,000ml                  |
| <b>Dimension</b><br>尺寸                   | 850(W)X800(D)X1500(H)mm  |
| <b>Weight</b><br>重量                      | Approx. 420kg            |
| <b>Interaction chamber</b><br>分散单元规格     | 100µm<z/y type>          |

### NANO DISPERSER (NH 500 Special)



|  |                          |
|--|--------------------------|
| <b>Operating Pressure</b><br>使用压力 (最高压力) | 2,500bar [Max. 2,750bar] |
| <b>Flow rate</b><br>流量                   | Max. 500ml/min           |
| <b>Pump system</b><br>电机系统               | Hydraulic unit system    |
| <b>Inlet reservoir</b><br>料杯容量           | 2,000ml                  |
| <b>Dimension</b><br>尺寸                   | 1250(W)X700(D)X1670(H)mm |
| <b>Weight</b><br>重量                      | Approx. 600kg            |
| <b>Interaction chamber</b><br>分散单元规格     | 75/100+400µm<z/y type>   |



# Specification of Nano Disperser

## Specification 规格

### NANO DISPERSER (NH 2000)



|  |   |
|--|---|
| <b>Operating Pressure</b><br>使用压力 (最高压力) | 1,500bar [Max. 2,000bar]                  |
| <b>Flow rate</b><br>流量                   | Max. 2,000ml/min                          |
| <b>Pump system</b><br>电机系统               | Hydraulic unit system(220/380V,3-ph,20hp) |
| <b>Inlet reservoir</b><br>料杯容量           | 2,000ml                                   |
| <b>Dimension</b><br>尺寸                   | 1900(D)X950(W)X1500(H)mm                  |
| <b>Weight</b><br>重量                      | Approx. 1,500kg                           |
| <b>Interaction chamber</b><br>分散单元规格     | 100/200/400 $\mu$ m<z/y type>             |

### NANO DISPERSER (NH 4000)



|  |   |
|--|---|
| <b>Operating Pressure</b><br>使用压力 (最高压力) | 1,500bar [Max. 2,000bar]                  |
| <b>Flow rate</b><br>流量                   | Max. 4,000ml/min                          |
| <b>Pump system</b><br>电机系统               | Hydraulic unit system(220/380V,3-ph,40hp) |
| <b>Inlet reservoir</b><br>料杯容量           | 2,000ml                                   |
| <b>Dimension</b><br>尺寸                   | 2100(D)X1000(W)X1050(H)mm                 |
| <b>Weight</b><br>重量                      | Approx. 2,500kg                           |
| <b>Interaction chamber</b><br>分散单元规格     | 100/200/400 $\mu$ m<z/y type>             |

### NANO DISPERSER (NH 8000)



|  |   |
|--|---|
| <b>Operating Pressure</b><br>使用压力 (最高压力) | 1,500bar [Max. 2,000bar]                  |
| <b>Flow rate</b><br>流量                   | Max. 8,000ml/min                          |
| <b>Pump system</b><br>电机系统               | Hydraulic unit system(220/380V,3-ph,50hp) |
| <b>Inlet reservoir</b><br>料杯容量           | -   |
| <b>Dimension</b><br>尺寸                   | 3500(D)X1000(W)X2100(H)mm                 |
| <b>Weight</b><br>重量                      | Approx. 3,000kg                           |
| <b>Interaction chamber</b><br>分散单元规格     | 100/200/400 $\mu$ m<z/y type>             |



Solution tank to prevent the solidification  
原料放凝固装置



Monitor and Alarm system  
显示屏及报警系统

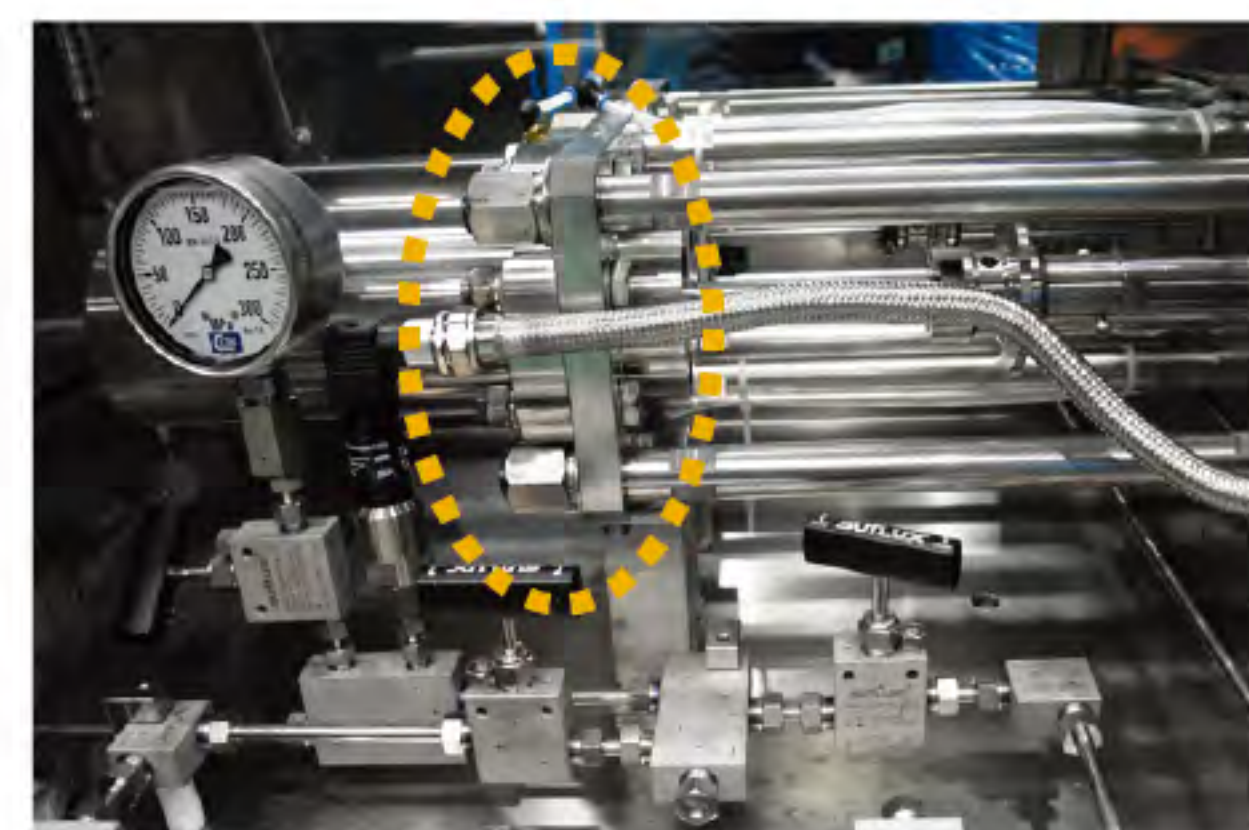

Cooling line on high pressure part  
高压泵体冷却装置

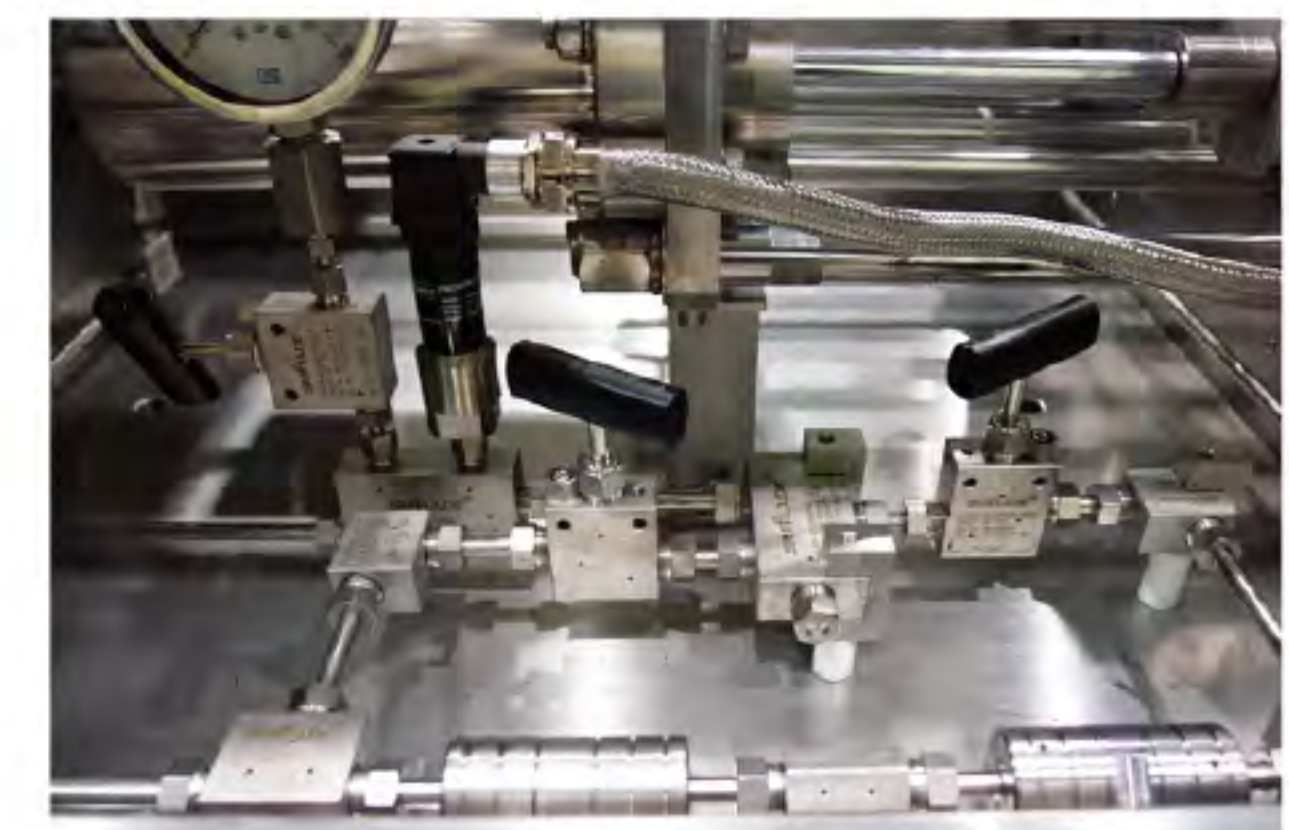

Back flushing system  
逆流清洗系统



## WIP(Warm Isostatic Press) series



### WIP for laboratory

| Series            | ISA-WIP500 | ISA-WIP1000 | ISA-WIP2000 | ISA-WIP3000 |
|-------------------|------------|-------------|-------------|-------------|
| Volume            | 0.5 ℓ      | 1 ℓ         | 2 ℓ         | 3 ℓ         |
| Pressure(bar)     | ~2,000     | ~2,000      | ~2,000      | ~2,000      |
| Pump              | Air Driven | Air Driven  | Air Driven  | Air Driven  |
| Closing type      | pin        | pin         | pin         | pin         |
| Temperature(°C)   | Max. 85°C  |             |             |             |
| Internal diameter | 50~100Φ    | 70~100Φ     | 80~120Φ     | 100~120Φ    |

### WIP for producing

| Series          | WIP-P Series  |
|-----------------|---|
| Volume          | ~100 ℓ (Select inner voume according to product size) |
| Pressure(bar)   | ~2,000  |
| Pump            | Air Pump/Pump   |
| Closing type    | Pin/Cover   |
| Temperature(°C) | Max. 85°C   |

## CIP(Cold Isostatic Press) series



### CIP for laboratory

| Series            | ISA-CIP500                | ISA-CIP1000 | ISA-CIP2000 | ISA-CIP3000 |
|-------------------|---------------------------|-------------|-------------|-------------|
| Volume            | 0.5 ℓ                     | 1 ℓ         | 2 ℓ         | 3 ℓ         |
| Pressure(bar)     | ~4,000                    | ~4,000      | ~4,000      | ~4,000      |
| Pump              | Air Driven/Hydraulic Pump |             |             |             |
| Closing type      | Pin                       |             |             |             |
| Temperature(°C)   | RT                        |             |             |             |
| Internal diameter | 50~100Φ                   | 70~100Φ     | 80~120Φ     | 100~200Φ    |

### CIP for producing

| Series          | CIP-C Series | CIP-P Series | CIP-Y Series   |
|-----------------|--------------|--------------|----------------|
| Volume          | ~2,000 ℓ     | ~100 ℓ       | ~300 ℓ         |
| Pressure(bar)   | ~2,000       | ~2,000       | ~2,000         |
| Pump            | Air Pump     | Air Pump     | Hydraulic Pump |
| Closing type    | C-clamp      | Pinp/Cover   | Yoke Flame     |
| Temperature(°C) | RT           | RT           | RT             |

### Feature of CIP

It is used to form the products at room temperature which are no need to change physical properties by temperature.



## Specification 规格



### Mini HiPPo

| Volume | Inner Diameter | Length | Pressure          | Temperature | Total Electric Power | Lay-Out       | Weight  |
|--------|----------------|--------|-------------------|-------------|----------------------|---------------|---------|
| 0.3 ℓ  | 54             | 150    | 6,000bar (600MPa) | 10~35 ℃     | 1 kw                 | 590*780*1,645 | 0.5 ton |

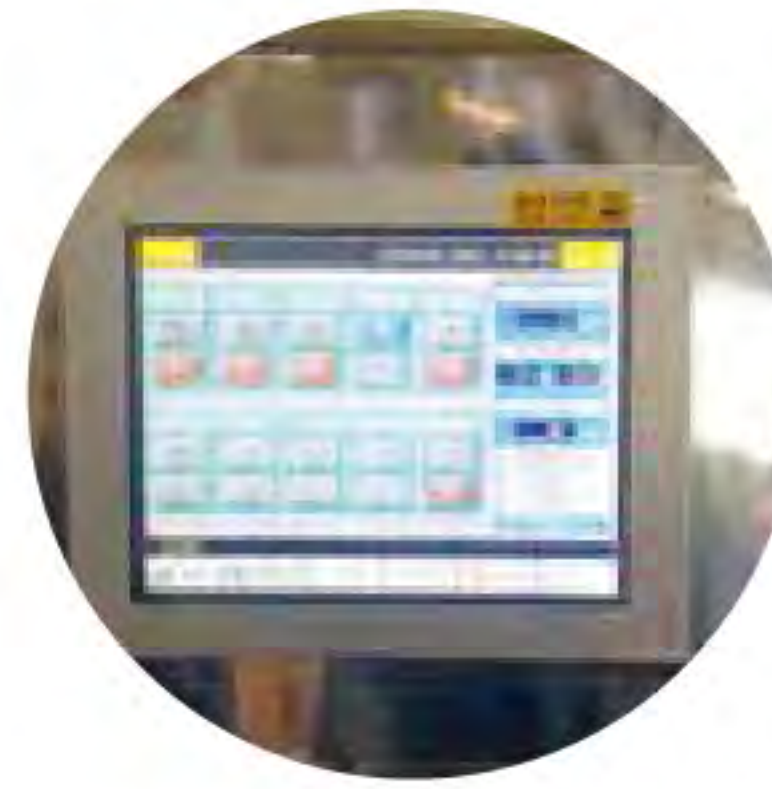

Touch Panel

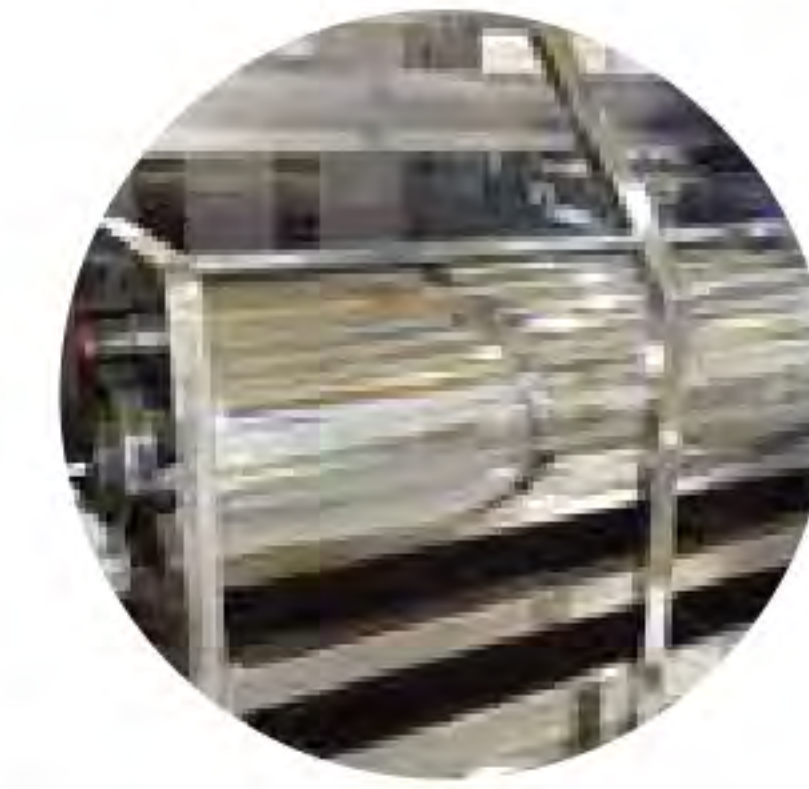

Pressure Vessel



Basket

### Small HiPPo

| Volume | Inner Diameter | Length | Pressure          | Temperature | Pump                         | Cycle Time                       | Production Capacity | Required Air | Lay-Out           | Weight |
|--------|----------------|--------|-------------------|-------------|------------------------------|----------------------------------|---------------------|--------------|-------------------|--------|
| 20 ℓ   | 160            | 1,000  | 6,000bar (600MPa) | 10~35 ℃     | 1intensifiers<br>1unit(30kw) | Maintaining<br>3 min<br>7~8/Hour | 12L/Cycle           | 7 bar        | 5,000*1,950*1,700 | 8 ton  |
| 50 ℓ   | 200            | 1,600  | 6,000bar (600MPa) | 10~35 ℃     | 1intensifiers<br>1unit(50kw) | Maintaining<br>3 min<br>7~8/Hour | 30L/Cycle           | 7 bar        | 5,800*2,450*2,000 | 15 ton |



### Large HiPPo

| Volume | Inner Diameter | Length | Pressure            | Temperature | Pump  | Cycle Time                       | Production Capacity | Required Air | Lay-Out            | Weight  |
|--------|----------------|--------|---------------------|-------------|---|----------------------------------|---------------------|--------------|--------------------|---------|
| 100 ℓ  | 300            | 1,420  | 6,000 bar (600 MPa) | 10~35 ℃     | 2intensifiers<br>1unit(100kw)                   | Maintaining<br>3 min<br>7~8/Hour | 65L/Cycle           | 7 bar        | 6,400*3,350*2,300  | 25 ton  |
| 150 ℓ  | 300            | 2,130  | 6,000 bar (600 MPa) | 10~35 ℃     | 2intensifiers<br>4intensifiers<br>1unit(150kw)  | Maintaining<br>3 min<br>7~8/Hour | 100L/Cycle          | 7 bar        | 6,600*3,350*2,400  | 30 ton  |
| 350 ℓ  | 380            | 3,090  | 6,000 bar (600 MPa) | 10~35 ℃     | 4intensifiers<br>6intensifiers<br>2unit(350kw)  | Maintaining<br>3 min<br>7~8/Hour | 230L/Cycle          | 7 bar        | 12,000*8,000*2,800 | 65 ton  |
| 450 ℓ  | 380            | 3,970  | 6,000 bar (600 MPa) | 10~35 ℃     | 8intensifiers<br>4unit(500kw)                   | Maintaining<br>3 min<br>7~8/Hour | 315L/Cycle          | 7 bar        | 13,800*8,000*4,000 | 80 ton  |
| 550 ℓ  | 420            | 3,980  | 6,000 bar (600 MPa) | 10~35 ℃     | 8intensifiers<br>10intensifiers<br>4unit(600kw) | Maintaining<br>3 min<br>7~8/Hour | 380L/Cycle          | 7 bar        | 15,000*8,000*5,000 | 100 ton |





 **ILSHIN AUTOCLAVE**

**Head office & factory(KOREA)**

ILSHIN AUTOCLAVE CO.,LTD  
255, Techno 2-ro, Yuseong-gu, Daejeon, Korea (Daedok techno valley)  
Tel : +82-42-931-6100 Fax : +82-42-935-6103  
Homepage : [www.suflux.com](http://www.suflux.com) / Homepage : [hpp.co.kr](http://hpp.co.kr)  
E-mail : [sales@suflux.com](mailto:sales@suflux.com)

**总公司&生产工厂 (韩国)**

日新高温高压设备有限公司  
韩国 大田市儒城区 科技2路255 (大德科技园)  
Tel: +82-42-931-6100 Fax: +82-42-935-6103  
Homepage: [www.suflux.com](http://www.suflux.com) / Homepage: [hpp.co.kr](http://hpp.co.kr)  
E-mail: [sales@suflux.com](mailto:sales@suflux.com)